

SCREENING FOR SKIN CANCER IN PRIMARY CARE:
IMPLEMENTATION OF DERMOSCOPY

A Dissertation
Submitted to the Graduate Faculty
of the
North Dakota State University
of Agriculture and Applied Science

By
Erin Marie Hencley

In Partial Fulfillment of the Requirements
for the Degree of
DOCTOR OF NURSING PRACTICE

Major Department:
Nursing

March 2017

Fargo, North Dakota

ProQuest Number: 10266493

All rights reserved

INFORMATION TO ALL USERS

The quality of this reproduction is dependent upon the quality of the copy submitted.

In the unlikely event that the author did not send a complete manuscript and there are missing pages, these will be noted. Also, if material had to be removed, a note will indicate the deletion.



ProQuest 10266493

Published by ProQuest LLC (2017). Copyright of the Dissertation is held by the Author.

All rights reserved.

This work is protected against unauthorized copying under Title 17, United States Code
Microform Edition © ProQuest LLC.

ProQuest LLC.
789 East Eisenhower Parkway
P.O. Box 1346
Ann Arbor, MI 48106 – 1346

North Dakota State University
Graduate School

Title

SCREENING FOR SKIN CANCER IN PRIMARY CARE:
IMPLEMENTATION OF DERMOSCOPY

By

Erin Marie Hencley

The Supervisory Committee certifies that this *disquisition* complies with North Dakota State University's regulations and meets the accepted standards for the degree of

DOCTOR OF NURSING PRACTICE

SUPERVISORY COMMITTEE:

Dean Gross, Ph.D., FNP-BC, RN

Chair

Sheryll Clapp, MSN, FNP-BC, RN

Richard W. Blaine, MD

Kelly Buettner-Schmidt, Ph.D., RN

Eugene Berry, Ph.D.

Approved:

April 4th, 2017

Date

Carla Gross, Ph.D., RN

Department Chair

ABSTRACT

Skin cancer affects millions of individuals each year. Cutaneous malignant melanoma, which only accounts for a small portion of all skin cancers, is the most serious and is associated with the highest mortality. Education on the prevention and identification of skin cancers, for both the public and for healthcare providers, is paramount in stopping the development and progression of skin cancer, especially melanoma. In addition to education and primary prevention, secondary prevention strategies include routine skin examinations. Currently, healthcare providers only perform routine skin examinations at less than 21% of all annual physical examinations (Curiel-Lewandrowski, Chen, & Swetter, 2012). Barriers to performing routine skin examinations include lack of training and lack of a consistent screening methodology (Liebman et al., 2012).

Based on these identified barriers and need for a consistent skin cancer screening technique, an educational seminar and resource was created, and presented to healthcare providers at Student Health Services at North Dakota State University. The purpose of this practice improvement project was to educate and train healthcare providers on the practice of dermoscopy with the intent to improve knowledge and comfortability with the clinical application of dermoscopy.

Pre- and post-implementation surveys were used to compare healthcare providers' knowledge of general skin cancer topics, knowledge level of dermoscopy, opinions on the usefulness of dermoscopy and comfortability with the practice of dermoscopy. Comfortability, knowledge, and feelings of usefulness towards the practice of dermoscopy increased among providers by the completion of the three-month implementation period. By delivering a short training course to providers on the use of dermoscopy during routine skin examinations, an

increase was also seen in the knowledge of healthcare providers on the topic of general skin cancer prevention and education overall.

ACKNOWLEDGEMENTS

The success of my Doctor of Nursing Practice journey would not have been possible without the support and guidance from others. I would first like to thank my advisor and committee chair, Dr. Dean Gross, for his unwavering support, wisdom, and patience throughout this process and the entirety of my doctoral education. I would also like to thank my other committee members, Sheryll Clapp, Dr. Kelly Buettner-Schmidt, Dr. Richard W. Blaine, and Dr. Eugene Berry for providing their time, expertise, feedback, and positive attitudes while completing my practice improvement project. The dedication and guidance from each committee member is truly appreciated and will never be forgotten.

I would also like my family and friends for their unending love, encouragement, and support throughout my journey towards my Doctor of Nursing Practice degree. My parents, Robert and Cynthia, and my sister, Alyssa, provided me with endless courage, faith, and motivation throughout this process. A special thank you to my parents for instilling within me strong values, ambition, and appreciation for education. Without your continued support and encouragement, I would not have accomplished what I have today.

DEDICATION

I dedicate this dissertation to my family, especially my parents, Robert and Cynthia.

TABLE OF CONTENTS

ABSTRACT.....	iii
ACKNOWLEDGEMENTS.....	v
DEDICATION.....	vi
LIST OF FIGURES.....	xi
CHAPTER ONE. INTRODUCTION.....	1
Background.....	2
Significance of the Proposed Project.....	3
Purpose of the Project.....	4
CHAPTER TWO. LITERATURE REVIEW.....	5
Forms of Skin Cancer.....	5
Precancerous Skin Lesions.....	5
Basal Cell Carcinoma.....	7
Squamous Cell Carcinoma.....	8
Cutaneous Malignant Melanoma.....	9
Skin Cancer Screening Recommendations.....	11
Current Skin Cancer Screening Techniques.....	14
ABCDE Rule.....	15
“Ugly Duckling” Sign.....	15
Glasgow Seven-Point Checklist.....	16
Dermoscopy.....	17
Background.....	17
Clinical Role of Dermoscopy.....	18
Use in Primary Care.....	19
Dermoscopic Examination.....	20

Dermoscopic Algorithms	22
ABCD Dermoscopy Rule	22
Menzies Method	25
Seven-point Checklist.....	25
Three-point Checklist	25
Pattern Analysis.....	26
Limitations.....	26
Summary	27
CHAPTER THREE. THEORETICAL FRAMEWORK.....	28
The Iowa Model of Evidence-Based Practice	28
Topic Selection	28
Team Formation	29
Evidence Retrieval.....	29
Evidence Grading	30
EBP Standard Development	30
EBP Implementation	30
Evaluation.....	30
Summary	31
Diffusion of Innovation Theory	31
Diffusion.....	31
Qualities of Innovation	32
Adopter Categories	34
Summary	34
CHAPTER FOUR. PROJECT DESCRIPTION.....	35
Congruence of the Project to the Organization’s Strategic Plan/Goals.....	35

Project Objectives	35
Project Design	36
Project Resources	38
Project Evaluation	40
Objectives	40
Evaluation Model	42
Protection of Human Subjects.....	42
CHAPTER FIVE. RESULTS	45
Sample Demographics and Data Analysis	45
Data Results.....	45
Statement One	47
Statement Two.....	47
Statement Three.....	47
Statement Four.....	47
Question One	48
Question Two	49
CHAPTER SIX. DISCUSSION AND RECOMMENDATIONS	50
Quantitative Results and Interpretations	51
Qualitative Results and Interpretations	52
Advanced Practice Nursing Implications	53
Objective One	53
Objective Two	53
Objective Three	54
Project Limitations and Recommendations for Future Research.....	55
Personal Growth and Development.....	58

REFERENCES	60
APPENDIX A. PERMISSION TO USE AND/OR REPRODUCE THE IOWA MODEL (1998).....	68
APPENDIX B. THE IOWA MODEL OF EBP	69
APPENDIX C. APPROVAL FROM THE NDSU STUDENT HEALTH CENTER FOR PROJECT IMPLEMENTATION	70
APPENDIX D. PERMISSION TO USE DERMNET NZ IMAGES	71
APPENDIX E. PRE-IMPLEMENTATION SURVEY	72
APPENDIX F. POST-IMPLEMENTATION SURVEY	73
APPENDIX G. WELCH ALLYN EPISCOPE SKIN SURFACE MICROSCOPE BROCHURE (A)	74
APPENDIX H. WELCH ALLYN EPISCOPE SKIN SURFACE MICROSCOPE BROCHURE (B)	75
APPENDIX I. WELCH ALLYN EPISCOPE SKIN SURFACE MICROSCOPE USER INFORMATION.....	76
APPENDIX J. DERMLITE DL100 POCKET EPILUMINESCENCE MICROSCOPY DEVICE BROCHURE (A)	77
APPENDIX K. DERMLITE DL100 POCKET EPILUMINESCENCE MICROSCOPY DEVICE BROCHURE (B).....	78
APPENDIX L. SKIN CANCER HANDOUT	79
APPENDIX K. EXECUTIVE SUMMARY.....	80
Background and Significance.....	80
Project Summary	80
Results	81
Recommendations	81

LIST OF FIGURES

<u>Figure</u>	<u>Page</u>
1. Erythematous slightly scaly patch representative of a superficial basal cell carcinoma.....	7
2. An erythematous, hyperkeratotic papule present in cutaneous squamous cell carcinoma.....	9
3. Superficial spreading melanoma on the left posterior leg of a 29-year-old woman.....	11
4. ABCD method of dermoscopy.....	24
5. Three-point checklist of dermoscopy.....	26
6. Logic model for practice improvement project objectives.....	42
7. Dermoscopy pre-implementation survey results.....	46
8. Dermoscopy post-implementation survey results.....	48
9. Comparison of dermoscopy pre- and post-implementation survey results.....	49

CHAPTER ONE. INTRODUCTION

Skin cancer is among the most common types of cancer. Every year approximately 5.4 million basal cell and squamous cell carcinomas are diagnosed in 3.3 million Americans. Cutaneous malignant melanoma only accounts for a small percentage of overall skin cancers, estimated to affect 76,380 people in 2016, but it is the hardest to treat and associated with the highest mortality. Due to this, melanoma accounts for the most skin cancer deaths; about 10,000 of more than 13,650 skin cancer deaths every year (American Cancer Society [ACS], 2016). The overall incidence of skin cancer, specifically melanoma, doubled between 1982 and 2011 and is predicted to continue to increase over the next 15 years (Centers for Disease Control [CDC], 2015). Directing the focus of the public towards reducing modifiable risk factors and encouraging increased screening rates among healthcare providers, could prevent 20% of new predicated cases of melanoma within the next 15 years (ACS, 2016).

Risks for developing skin cancer include ultraviolet (UV) radiation exposure, fair skin and hair, numerous or atypical moles, history of severe sunburns, exposure to certain chemicals, compromised immune system, and personal or family history of skin cancer (ACS, 2016). Reducing risk for developing skin cancer includes primary prevention strategies. These strategies include sun protection measures, such as, avoidance of midday sun, seeking shade during the day, donning sun protective clothing and proper use of sunscreen; applying at least SPF 30 every two hours. Additional guidelines provided by the National Council on Skin Cancer Prevention recommend that people avoid sun tanning and tanning beds, use extra caution near water, snow and sand due to the reflection of damaging rays responsible for sunburn. Maintaining adequate amounts of Vitamin D through healthy diet and supplements is also strongly recommended (National Council on Skin Cancer Prevention [NCSCP], 2016).

Secondary prevention for skin cancer includes routine skin examinations. The purpose of screening skin for cancerous lesions is to identify lesions suspicious for skin cancer, especially melanoma. Guidelines vary, but major skin cancer organizations recommend individuals perform monthly head to toe skin self-examinations and receive general cancer screenings every three years (ACS, 2016). Screening guidelines for those with current or personal history of skin cancer recommend more frequent skin examinations by a provider; ranging from every three months to annually depending on patient history and provider judgment.

Background

Due to the increasing incidence of skin cancers, specifically melanoma, healthcare providers play a pivotal role in promoting and completing full body skin examinations. Melanoma prognosis is dependent on tumor thickness at time of diagnosis; thinner tumors are associated with an improved cure rate. Multiple studies have demonstrated that melanoma tumors found by healthcare providers during routine skin examinations are thinner than those found by the patient themselves (Geller & Swetter, 2016).

Skin examinations by healthcare providers in primary care setting are usually completed as naked eye examinations (NEE), meaning providers use only their eyes to examine skin lesions. Differing techniques and comfort levels with skin lesion identification lead to varied exam results in primary care. Use of instruments to assist with screenings have been found to increase provider comfortability and overall accuracy of the exam. One of the most recognized instruments utilized for screenings is a dermatoscope, which is used to complete skin examinations via the practice of dermoscopy.

Dermoscopy is a noninvasive technique that uses light and magnification to aid in visualization and recognition of pigmented skin lesions and early detection of melanoma

(Chevolet et al., 2014). Dermoscopy is currently utilized by most dermatologists and recently gaining popularity throughout primary care settings. The practice of dermoscopy has allowed for earlier recognition of suspicious skin lesions and earlier diagnosis of melanoma tumors when compared to naked eye skin examinations (Curiel-Lewandrowski et al., 2012). Expanding dermoscopy to primary care settings allows for increased skin cancer screening rates, and improved management decision making by allowing the provider to offer reassurance, make a referral, or perform a biopsy (Jaimes & Marghoob, 2015). The most significant benefit linked to the early identification of thinner melanoma tumors has been demonstrated through reduced melanoma-associated mortality in multiple studies (Curiel-Lewandrowski et al., 2012).

Significance of the Proposed Project

Despite the rising number of melanoma occurrences, annual skin examinations by primary care providers remain at a low number. Documented prevalence of annual clinical skin examination by a healthcare provider is inconsistent across countries and provider types, but ranges from only 8%-21% (Curiel-Lewandrowski et al., 2012). Lack of training and exposure to skin lesions may be a barrier for healthcare providers. Primary care providers in the United States may not be prepared to identify skin cancers in the early stages due to insufficient training, which can result in lack of confidence in making skin cancer diagnoses (Curiel-Lewnadrowski et al., 2012). Specific methods can act as guides for healthcare providers during skin examinations, like the ABCDE method, but may not be used consistently in practice or applicable across all patients with skin concerns.

Introducing dermoscopy to primary care providers is intended to break down barriers associated with skin cancer screenings. Providing a skin examination technique like the practice

of dermoscopy to NDSU providers, offers a concrete and evidence-based method that can be used for the entirety of their careers.

Purpose of the Project

Current skin cancer screening with a NEE using the ABCDE method reports varied sensitivity and specificity, ranging from 43% to 99.6% (Herschorn, 2012). The ABCDE method was intended to help nondermatologists differentiate common nevi and melanomas; it was not meant for the detection of all malignant skin lesions (Herschorn, 2012). Applying dermoscopy to skin examinations allows primary care providers with an enhanced ability to be more confident in identifying lesions, both benign and malignant (Kownacki, 2014). The purpose of this project is to increase the prevalence of screening for skin cancers in primary care by presenting providers with a learning module and clinical practice with dermoscopy. Intent is also to increase provider confidence in identifying and monitoring skin lesions with a dermatoscope within their setting of care.

CHAPTER TWO. LITERATURE REVIEW

Incidence of skin cancer rates in the United States is on the rise, with current estimates that one in five Americans will develop some form of skin cancer during their lifetime (American Academy of Dermatology [AAD], 2015). The two most common forms of skin cancer, basal cell and squamous cell carcinomas, have a high cure rate with early detection and appropriate treatment. A third form of skin cancer, cutaneous malignant melanoma, is far less common than basal and squamous cell carcinomas, but is, again, associated with the highest fatality rate. Cutaneous malignant melanoma represents only three to five percent of all skin cancers, yet is responsible for 75% of all deaths related to skin cancer (Baumgardner & Rogers, 2014). Age, gender, skin type, and sun exposure play a large role in the development of skin cancers.

Primary prevention behaviors and secondary prevention and detection strategies by healthcare providers are imperative to reducing associated morbidity and mortality with all types of skin cancer (Oliveria, Heneghan, Cushman, Ughetta, & Halpern, 2011). Screening for skin cancer, although associated with both weak and strong recommendations, has resulted in earlier diagnoses of skin cancer, especially cutaneous malignant melanoma (Baumgardner et al., 2014). Newer research has provided increasing support for skin cancer screenings that are done using a tool called a dermatoscope to further evaluate skin lesions, especially in the setting of primary care.

Forms of Skin Cancer

Precancerous Skin Lesions

Sun exposure via ultraviolet (UV) radiation can cause considerable damage to the mechanical structure and function of the layers of the skin. Skin damage can result in sunburns,

dry skin, and premature wrinkles. Extended amounts of sun damage can result in both precancerous skin lesions called actinic keratoses and benign skin lesions called seborrheic keratoses (Harvard Health Publications, 2013). Actinic keratoses (AK) are rough, scaly patches of skin commonly with an erythematous base covered by a hyperkeratic scale. They can vary in color from white/tan to pink/red. Tissue surrounding AK may resemble sun-damaged skin with irregularities in pigment, and presence of telangiectasia, erythema, or collagenosis and are often less than one centimeter in size (Primary Care Dermatology Society [PCDS], 2016). These lesions commonly develop in groups of multiple confluent lesions on sun-exposed areas such as the face, scalp, lips, and dorsal side of the hands and forearms. AK are a warning sign of increased risk of skin cancer and between 10 and 15% of AK eventually change into squamous cell carcinoma (AAD, 2015). “The presence of ten AK is associated with a 14% risk of developing squamous cell carcinoma within five years” (PCDS, 2016, para. 1).

Seborrheic keratoses (SK) are benign growths that originate from keratinocytes and appear in middle age or later. Sun exposure, family history of SK, and skin type all contribute to the development of SK. These start as small bumps, which slowly thicken and develop a warty, stuck on appearance with sharply demarcated borders. The color of SK can range from light tan to black with size ranging from less than a centimeter to greater than one inch (AAD, 2015). SK commonly form on the trunk, scalp, face and neck, but not on palms or soles and the skin surrounding the SK is usually intact and not affected (AAD, 2015).

Precancerous lesions can resemble AK, SK, warts, dysplastic nevi, and forms of skin cancer, making skin cancer screenings and histological findings pertinent to diagnosis and treatment. Understanding specific clinical findings that are associated with differential diagnoses is foundational to make an accurate diagnosis and treat appropriately.

Basal Cell Carcinoma

More than two million cases of basal cell carcinoma (BCC) are diagnosed every year in the United States, making it the most common form of skin cancer (AAD, 2015). BCC is a nonmelanocytic form of skin cancer that develops from basal cells in the skin. BCC often forms on areas of the skin that have received years of sun exposure, with or without associated sunburns. Exposed areas like, the head, neck, ears, back of hands, face, and nose are common places for BCC to develop. However, BCC can develop anywhere on the body, including the arms, legs, and trunk (AAD, 2015).

BCC typically appears as a small pink, painless lesion with a pearly center. As BCC grows, the pearly center may become indurated with rolled edges and crust or bleed (Harvard Health Publications, 2013). Lesions may present as nodular, crusted or scabbed in appearance. Since basal cells are normally found in the superficial layers of skin, without blood or lymphatic involvement, basal cell carcinomas rarely metastasize. Appropriate treatment and removal still needs to be completed since BCC can grow over time and cause surrounding skin and tissue damage (Harvard Health Publications, 2013).



Figure 1. Erythematous slightly scaly patch representative of a superficial basal cell carcinoma.

Squamous Cell Carcinoma

Squamous cell carcinoma (SCC) develops from keratinocytes of the epidermis and is the second most common type of skin cancer, representing approximately 20% of nonmelanoma skin cancers. There is an estimated annual incidence of 700,000 cases of SCC every year (Karia, Han, & Schmults 2013). Excessive sun exposure is the main instigator for SCC, but genetic factors, chronic inflammation and current actinic keratosis also constitute increased risk. Immunosuppressive therapy, human papillomavirus infection, tobacco pipe smoking, long-term exposure to radiation or chemicals, and the following medical conditions: xeroderma pigmentosum, epidermolysis bullous, and albinism increase a person's lifetime risk. Predominant areas of tumor development include dorsal side of hands and forearms, faces, lips, and ears. Clinical signs of SCC include nodular, plaque-like, verrucous or ulcerated induration with concomitant inflammation to surrounding tissue. Lesions have a friable, keratotic surface that bleeds rather easily, and does not heal, or heals and reappears (PCDS, 2014).

Tumors can arise de-novo or from precursor skin lesions including actinic keratosis, chronic areas of inflammation, scars and Bowen's disease. De-novo tumors arise in the epidermis and typically remain localized, with only a small potential to expand into the dermal layers of the skin. De-novo tumors, on average grow to about 1.2 cm, but can grow as large as 5.0 cm. Invasive SCC that arises from precursor lesions tend to grow at a more rapid rate than other skin cancers and left untreated, can penetrate the deeper layers of the skin, surrounding tissue and metastasize to lymph nodes and distant organs. Tumors associated with invasive SCC tend to be 0.5 to 1.5 centimeters in diameter, but can become larger than two centimeters. These lesions often have poorly differentiated borders (Lim & Asgari, 2016).



Figure 2. An erythematous, hyperkeratotic papule present in cutaneous squamous cell carcinoma.

Cutaneous Malignant Melanoma

The American Cancer Society estimates that approximately 2% of Americans will receive a diagnosis of melanoma, resulting in one in 52 Americans receiving a melanoma diagnosis during their lifetime (Little & Eide, 2012). Annually, 75,000 cases of melanoma are diagnosed and approximately 9,000 people will die from their melanoma diagnosis. Incidence rates of melanoma have been rising over the past decades, with the annual incidence rate increasing more than 15-fold since 1930 (Baumgardner, 2014).

Incidence rates are higher in men than in women. Melanoma represents the fifth leading cause of cancer in men and the seventh in women (Sigel, Ma, Zou, & Jemal, 2014). Recent trends show an overall increase in cutaneous malignant melanoma in young women, ages 15-39. The etiology of this recent increase is multifactorial, but a large portion is believed to be caused from the use of UV-emitting indoor tanning trends. Exposure to solar UV rays directly damages the DNA, proteins and lipids within cells, leading to photoaging, immunosuppression, and carcinogenesis (Baumgardner et al., 2014).

Cutaneous malignant melanoma most commonly occurs on the lower extremities in women and on the trunk in men. Most lesions develop on sun-exposed skin, particularly skin that has been sunburned in the past. Men and women with high total body nevus counts, atypical nevi, family or personal history of skin cancer, certain genetic makeup components, and specific phenotypic traits are at a higher risk for the development of melanoma (Curiel-Lewandrowski, 2016). Overall incidence also increases with age.

Five stages of melanoma exist. Stage 0 is melanoma in situ, stages I and II are localized cutaneous disease, stage III is regional nodal disease and stage IV is metastatic disease. When melanoma is identified in early stages, stages 0-I, lesions can be excised and people can expect prolonged disease-free survival (Swetter & Geller, 2015). People diagnosed with stage II-IV melanoma have a higher chance of mortality from the disease due to the tendency for these lesions to metastasize. Survival rates are indirectly proportionate to tumor thickness at diagnosis and vary from 92% when lesions are less than 1.01 mm, to 50% when lesions are greater than four mm thick (Swetter & Geller, 2015).

Tumors typically originate in the epidermal layer of the skin where they may remain for several years growing horizontally. Once melanoma tumors penetrate the dermis, they are growing vertically and have a high metastatic potential. The growth of the tumor depends on the subtype of melanoma. Four major subtypes exist: superficial spreading melanoma, lentigo maligna, acral lentiginous, and nodular melanoma (Little & Eide, 2012). Each subtype of melanoma may present differently. Superficial spreading melanoma tumors typically display the ABCDE warning signs, which are further discussed in subsequent paragraphs. Overall, these tumors tend to be flat or minimally elevated with variegated pigmentation (brown, black, blue, pink), irregular borders, and larger than 6 mm in diameter (McCourt, Dolan, & Gormley, 2014).

Lentigo maligna melanoma also displays the ABCDE warning signs, but grows more slowly and demonstrates a more variegated shape. Acral lentiginous melanoma starts as a flat discolored patch of skin that later becomes thickened with an irregular surface. These tumors typically appear on the palms, soles, and nails. Nodular melanoma can be more difficult to diagnose at an early stage as it most commonly presents as a rapidly enlarging, dark pigmented bump, but can also present amelanotic or ulcerated (McCourt et al., 2014).



Figure 3. Superficial spreading melanoma on the left posterior leg of a 29-year-old woman.

Early detection of melanoma is paramount in survival rates and patient outcomes. Detection can be challenging due to the variety of presenting factors associated with melanoma subtypes, however, the use of diagnostic aids and full body skin examinations is associated with thinner tumors and increased survival rates (Swetter & Geller, 2015).

Skin Cancer Screening Recommendations

Skin cancer screenings are not consistently performed in primary care settings. Most often, if a provider performs a full body skin examination it is at the request of the patient. One reason for inconsistent screenings comes from inconsistent professional guidelines, which range from no formal recommendations to annual skin cancer screening for all adults (Oliveria et al.,

2011). In 2001, the U.S. Preventative Services Task Force (USPSTF, 2015) concluded that there was not enough evidence to recommend for or against routine skin cancer screening. However, the USPSTF (2015, para. 1) does recommend that doctors, “be aware that fair-skinned men and women aged 65 and older, and people with atypical moles or more than 50 moles, are at a greater risk for melanoma.” Additional recommendations include that doctors should look for abnormalities on the skin while performing physical examinations for other reasons (USPSTF, 2015). A review of this guideline done in 2009 proposed the same recommendation, but acknowledged large knowledge gaps in the relevant research literature (Baumgardner et al., 2014).

The above recommendation applies to the general adult population who do not have a history of premalignant or malignant lesions. Alternatively, the ACS Guidelines for Early Detection of Cancer recommend that skin examinations be completed on all patients aged 20 years and older during their annual physical examination as well as monthly skin self-examinations. During this annual physical examination, a cancer-related examination is recommended to be completed in full. This includes exams for cancers of the thyroid, oral cavity, lymph nodes, testes and ovaries, depending on the age and gender of the patient, in addition to skin cancer screening (American Cancer Society [ACS], 2015). The American Academy of Dermatology recommends that high risk individuals perform frequent skin self-examinations and seek professional skin examinations at least once per year (American Academy of Dermatology [AAD], 2015). High risk individuals are identified as those with a strong family history of melanoma, multiple atypical moles, high nevus count (those with > 100 nevi), sun or ultraviolet exposure, and phenotypic traits (light skin pigmentation, blonde or red hair color, high-density freckling and light eye color) (Geller & Swetter, 2015).

Sun or ultraviolet exposure, specifically in adolescents and young adults is associated with a significant increased risk for the development of skin cancers. Approximately 35% of adults, 59% of college students and 17% of adolescents have used a tanning bed in their lifetime and Caucasian girls and young women make up nearly 70% of tanning salon customers (Howlader et al., 2015; Wehner et al., 2014). Current melanoma trends reveal a faster increase of the incidence of melanoma in women aged 15-29 years than in young men of the same age (Howlader et al., 2015).

Individuals who use tanning beds prior to the age of 35, increase their risk for melanoma by 59%, and the risk continues to rise with each use (Boniol, Autier, Boyle, & Gandini, 2012). As well as an increased risk for melanoma, those who use a tanning bed, even once, place themselves at an increased risk for developing basal cell and squamous cell carcinomas; risk of 29% and 67%, respectively (Wehner et al., 2014). Because of the increasing rates of melanoma in this young adult population, screening for skin cancers and precancers, specifically melanoma, is strongly recommended, especially within clinics on college campuses. Tamra Garberg DNP, FNP (2008) conducted a survey among NDSU students regarding indoor tanning use, which revealed that 72% of participants had used an artificial tanning bed within the past month and 60% of individuals sought at least a medium color tan. Since her survey, more indoor tanning salons near the NDSU campus have opened, demonstrating an increased urgency for providers, specifically providers on college campuses, to accurately assess for skin cancer in this young adult population. In addition to screening young adults for melanoma, promoting awareness of the harmful effects of UV exposure and sun protective techniques are important strategies for reducing overall risk (Weir et al., 2011).

As current studies continue to evaluate the benefits, harms and quality of skin cancer screening within the general adult population, many professionals expect to see more consistent guidelines in favor of regular skin cancer screening completed in the general population. Swetter et al. (2012) reaffirmed that detection of thinner melanoma lesions reduces mortality through studies conducted in California and Michigan. These studies demonstrated that whole body skin examinations completed by a healthcare provider were associated with thinner tumors. Patients who also used a visual aid of melanoma and performed their own WBSE were more likely to have thinner tumors (Swetter, Pollitt, Johnson, Brooks, & Geller, 2012). Additional studies suggest that skin cancer screenings would likely result in skin cancers being detected at earlier stages, which would allow for earlier intervention (Buckley & McMonagle, 2014).

The type of screening done by healthcare providers can affect the quality of the skin cancer screening as a whole. Varying sensitivities and specificities exist depending on the type of skin examination done and whether tools were used to assist in completing the exam. Current types of skin examinations are discussed in subsequent paragraphs.

Current Skin Cancer Screening Techniques

Several sets of criteria have been developed for the identification of pigmented and nonpigmented lesions. Focus is placed on identifying malignant lesions, specifically melanoma due to the high rate of mortality associated with its diagnosis. Recognizing melanoma may be challenging because of the endless variations that can exist within skin lesions. However, multiple clinical features of a skin lesion have been identified that are suggestive of melanoma. If these clinical features are observed during a routine skin examination, prompt referral to a dermatologist for biopsy is recommended. Three main diagnostic tools have been created to assist healthcare providers identify skin lesions suspicious for malignancy. The ABCDE rule,

Glasgow seven-point checklist, and “ugly duckling” sign are common techniques used by providers for naked eye skin examinations.

ABCDE Rule

Developed in 1985, the ABCDE rule assesses skin lesions for the “presence of asymmetry (A), irregular or ill-defined borders (B), variation in color from one area of the same lesion to another (C), diameter larger than six mm (D), and if the mole is evolving; changing size, shape or color (E)” (Baumgardner et al., 2014, p. 36). The purpose of this rule was to assist in the diagnosis of early, superficial melanomas that may be mistaken for benign pigmented lesions. Sensitivity and specificity can vary greatly depending on if one criterion is used or if all five criteria are included in lesion identification. When all five criteria are present, sensitivity and specificity range from 43% and 99.6% respectively and from 97.3% and 36% respectively when only one criterion is met (Herschorn, 2012). Because of the low specificity, but high sensitivity when only one criterion is used, there is a higher chance that many benign lesions would be referred or biopsied. The opposite occurs when all five criteria are used; there is higher specificity, but also an increased chance that malignant lesions may be missed. Limitations exist depending on provider experience and patient perspective of any mole changes reported. The ABCDE rule has limited applicability since it is not useful in identification of melanomas within the nail (Herschorn, 2012).

“Ugly Duckling” Sign

The “ugly duckling” sign was developed to identify suspicious nevi on a person’s body as compared to their total body nevus profile. While most nevi tend to resemble each other, the “ugly duckling” nevus will look different than surrounding nevi (Geller & Swetter, 2015). Even if a nevus does not fulfill the ABCDE criteria, it still may fall into the “ugly duckling” category.

Predictive value of the “ugly duckling” sign has not been studied, but providers continue to use this approach to identify overall pattern recognition and atypical nevi (Geller & Swetter, 2015).

Glasgow Seven-Point Checklist

The Glasgow seven-point checklist was developed in the 1980s with the intent to help primary care providers identify skin lesions suspicious for melanoma (Walter, 2013). The original checklist contains seven features each scoring one point. Any lesion scoring greater than or equal to three points is considered suspicious and should be referred or biopsied. In the late 1980s, the checklist was updated by splitting the seven features in major features (scoring two points) and minor features (scoring one point). Major features include a change in the size of the lesion, irregular pigmentation, and irregular border. Minor features include inflammation, itch or altered sensation, diameter larger than seven mm, and oozing or crusting of the lesion (Walter, 2013).

Under analysis, the Glasgow seven-point checklist (both original and weighted) has a sensitivity of 100% and a specificity of 37% for the detection of benign melanocytic lesions. When only melanoma identification was studied, the Glasgow seven-point checklist had a sensitivity of 79% (Swetter & Geller, 2015). One study showed that the presence of one feature, irregular borders, showed large statistical significance for the detection of melanoma when compared with other individual features (Walter et al., 2013).

Combining the aforementioned methods with the use of a technological diagnostic aid, like a dermatoscope, can improve overall specificity and sensitivity in the identification of malignant lesions. A meta-analysis of studies comparing dermoscopy to NEE shows a sensitivity of 71% with NEE compared with a sensitivity of 90% when dermoscopy was utilized (Herschorn, 2012). Additionally, these results revealed no decrease in the specificity with

dermoscopy, indicating that, “dermoscopy improved the diagnostic accuracy without increasing the number of misdiagnosed nonmelanomas” (Herschorn, 2012, p.741). The combination of dermoscopy with these algorithms represents a first-line tool for screening of patients with few or multiple skin lesions (Lallas, Apalla, & Chaidemenos, 2012).

Dermoscopy

Dermoscopy is a technique used in the diagnosis of pigmented skin lesions and early detection of melanoma. The practice of dermoscopy requires the use of a dermatoscope, which is a hand-held tool that uses light and magnification to visualize skin lesions at 10-fold the magnification (Herschorn, 2012). This magnification allows for microscopic visualization of dermoscopic characteristics resulting from the presence of melanin and hemoglobin in the epidermis, dermoepidermal junction and the upper dermis (Pluddemann et al., 2011).

Background

Skin surface microscopy was first pioneered in 1663 on nail and lip capillaries followed by the development of the first binocular dermatoscope in 1916 by Carl Ziess. Portable dermatoscopes became available in 1958 with the establishment of algorithms for their use shortly thereafter (Rudnicka, Olszewska, Majsterek, Czuwara, & Slowinska, 2006). Three types of dermatoscopes are now available: a nonpolarized dermatoscope that requires contact with the skin to visualize lesions and polarized light dermatoscopes that are made in both a contact and noncontact variety. Contact methods provide increased illumination and enhanced clarity of the lesion compared to noncontact methods. Polarized light penetrates the deeper layers of the skin allowing for enhanced colors, structures and vascularities (Jaimes & Marghoob, 2015). Since its first model, dermatoscopes have become more sophisticated and are currently used in patient care settings as a first line diagnostic tool.

Clinical Role of Dermoscopy

Using dermoscopy for the diagnosis of skin lesions has become increasingly popular within the United States. An estimated 81% of dermatologists used dermoscopy in their practice in 2014 compared with only 40% in 2010 (Murzaku, Hayan, & Rao, 2014). Increased use has been documented among primary care providers as well as increased diagnostic skills with the practice of dermoscopy. One study shows that after only a day of teaching dermoscopy to general providers, the providers achieved a reduction from 18:1 to 4:1 benign to malignant referrals due to improved correct lesion identification (Kownacki, 2014). Consistent results have been demonstrated in comparative studies. Menzies et al. (2009), reports a significant improvement in benign lesion to melanoma ratio of excised or referred lesions observed under dermoscopy compared to NEE (3.7:1 versus 9.5:1 respectively).

Comparative studies of NEE and dermoscopy show increased sensitivity and specificity for the diagnosis of melanoma when the practice of dermoscopy is utilized. Further analysis of the comparison between NEE and dermoscopy reveals that in the hands of experienced healthcare providers, dermoscopy is superior to NEE in the detection of melanoma (Chevolet et al., 2014). The addition of dermoscopy to a NEE increases the sensitivity in detecting melanoma from 71% to 91% (Swetter et al., 2015). Major implications of dermoscopy overall include a reduction in the number of false-positives lesions, leading to cost saving practices, reduced morbidity and less scarring (Pluddemann et al., 2011). Getting healthcare providers to the point where they feel comfortable with dermoscopy is paramount in the accuracy of identifying lesions using dermoscopy.

Multiple factors may contribute to the diagnostic accuracy of dermoscopy. Experience of the provider, the algorithm used for lesion evaluation, prevalence of melanoma in the patient

population, and patient related circumstances are examples of these factors (Marghoob & Jaimes, 2015). Short training courses in dermoscopy, involving half day PowerPoint presentations of lesion identification and diagnostic algorithms paired with supplemental materials, have enabled non-dermatologists in primary care settings to increase their accuracy in identifying melanoma through the application of diagnostic algorithms. Continued practice by primary care providers also correlates with increased accuracy. A study described by Herschorn (2012), indicates that a one day dermoscopy course (with supplemental materials) provides sufficient information for primary care providers to successfully practice dermoscopy for at least 16 months after the training if they remain exposed to dermoscopy in practice.

Use in Primary Care

Dermoscopy is primarily used by dermatologists and healthcare providers who specialized in dermatology. An estimated 84% of dermatology residency programs use dermoscopy, which is carried into use in dermatology practice. Use of dermoscopy in primary care settings is drastically lower, with the main reason due to inexperience and lack of training (Liebman et al., 2012). Lack of training in primary care refers to completing both NEE and dermoscopic skin examinations. Training plays a significant role in diagnostic accuracy of dermoscopy due to the numerous amounts of patterns, colors, structures, shapes and networks identifiable within a skin lesion. Teaching of dermoscopic techniques improves diagnostic accuracy, provider confidence and rate of skin cancer screenings done in primary care settings. (Liebman et al., 2012).

Training in dermoscopy has proven useful, even after a one-day course taught to primary care providers. Primary care providers who completed a one-day training course and performed dermoscopy regularly were shown to diagnose melanoma more accurately than primary care

providers who used NEE to do the same (Liebman et al., 2012). Formal training courses are not necessary for improvements in clinical practice however. Primary care providers in another study who were provided with a one hour recorded lecture along with an atlas for self-study, “significantly enhanced their sensitivity in identifying dermoscopic and clinical images of melanoma versus baseline and controls” (Liebman et al., 2012, p. 1021). In addition to the proven usefulness of dermoscopy training courses, providers can provide education during a dermoscopic exam, which is recommended for all patients, including preteens, adolescents, and young adults (Liebman et al., 2012).

According to the United States Preventative Task Force (USPSTF, 2012), providers are recommended to counsel all fair skinned children, adolescents, and young adults between the ages of 10 and 24 years about reducing their exposure to ultraviolet radiation to minimize their risk for skin cancer. Applying dermoscopy to clinics that specifically care for individuals in the adolescent and young adult age category offers both an opportunity for screening and for education in accordance with professional recommendation.

Dermoscopic Examination

Multiple techniques and algorithms exist as ways to systematically teach and perform dermoscopy for the identification of both malignant and non-malignant lesions. Multistep processes assist the healthcare provider with recognition of specific structures to either rule out or confirm a diagnosis (Marghoob & Jaimes, 2015). Colors, general structures and vascular structures are identified through dermoscopy and a histologic correlation has been established for most of these elements to assist providers in identification of skin lesions. Colors seen by dermoscopy include yellow, red, brown, blue, gray, black, and white. These colors represent the concentration of melanin within a skin lesion. Melanin appears gray and blue in the dermis,

brown in the epidermis and superficial dermis, and black in the stratum corneum. A red color indicates vascularity and a thrombosed lesion will appear black. Yellow is associated with keratin production and white indicates collagen formation as seen in scarring (Marghoob & Jaimes, 2015).

Structures visualized under dermoscopy are dependent on the amount of pigment, keratin, collagen, and vascularity (Marghoob & Jaimes, 2015). Different combinations of specific structures correlate with specific diagnoses. Hallmark structures of melanocytic nevi, or moles, include a pigment network, negative network, streaking, peripheral rim of globules, and homogeneous blue pigmentation in the lesion. Features of basal cell carcinoma include leaf-like structures, arborizing vessels, large blue/gray ovoid nests, shiny white blotches and strands, spoke-wheel-like and concentric structures, multiple blue/gray non-aggregated globules, and shallow ulceration. Combinations of red, blue, black, and purple are seen in cherry angiomas and angiokeratomas. Seborrheic keratoses contain milia-like cysts, comedo-like openings, gyri and sulci, moth-eaten borders, finger print-like structures, and sharply demarcated borders. Lastly, elements associated with melanoma include an atypical pigment network, blue-white veil, irregular streaking, atypical dots and globules, atypical vascular patterns, and angulated lines that appear in a zigzag pattern or polygons (Jaimes et al., 2015).

Vascular structures allow for diagnosis of pink skin lesions and lesions without pigment or other general dermoscopic structures. Lightly applied pressure is recommended when visualizing vascular structures so that the pressure does not obscure the vascular pattern (Oakley, 2015). Common vascular structures observed in melanocytic lesions include serpentine, corkscrew, comma-shaped and dotted vessels compared to glomerular, hairpin-shaped and arborizing vessels found in nonmelanocytic lesions (Marghoob & Jaimes, 2015). Specifically,

glomerular vessels are commonly associated with Bowen disease, squamous cell carcinoma and clear cell acanthoma whereas hairpin-shaped vessels with a white halo are observed in seborrheic keratoses and keratoacanthomas (Marghoob & Jaimes, 2015).

Dermoscopic Algorithms

Multiple algorithms exist to guide providers through a dermoscopic skin examination. Different algorithms are suggested depending on the practice and experience of the healthcare provider. Algorithms that extensively differentiate between subtypes of skin cancer lesions are more commonly used by experienced dermatologists whereas algorithms differentiating between only pigmented cancers are recommended for use in primary care settings. Algorithms intended for use in primary care settings tend to use short and straightforward dermoscopic criteria to assist the provider in basic evaluation of pigmented and nonpigmented lesions (Marghoob & Jaimes, 2015).

The main goal of dermoscopic exam in primary care is to help the provider decide whether to perform a skin biopsy, refer the patient to an expert, reassure the patient of a benign lesion, or clinically monitor the lesion over a period of time prior to intervention (Jaimes & Marghoob, 2015). Pattern analysis, lesion specific features, color and symmetry are all considered when forming a diagnosis using dermoscopy. Featured methods of dermoscopic evaluation typically used in primary care settings are described below.

ABCD Dermoscopy Rule

The ABCD rule of dermoscopy uses four dermoscopic criteria to assess pigmented skin lesions. This method, created in 1994, is thought to be the most helpful for healthcare providers who have little to no experience with dermoscopy due to the simplicity and reliability of the algorithm (Nachbar et al., 1994). The four criteria of the ABCD rule include asymmetry, border

sharpness, colors, and dermoscopic structures. Asymmetry evaluates the contour and distribution of colors within each lesion on multiple axes. Border sharpness refers to the presence of abrupt cutoffs at the edge of the lesion. Color refers to any presence of white, red, light brown, dark brown, blue-gray, or black within the lesion. Dermoscopic structures evaluate the existence of five main structures: pigment network, homogenous areas greater than 10% of the lesion, dots, globules, and branch like streaks (Marghoob & Jaimes, 2015). Each category is scored based on specific criteria and then all categories are totaled. Scores can range between 1 and 8.9 with any lesion scoring less than 4.75 deemed benign. Lesions scored 4.75 to 5.45 are considered suspicious and lesions scored greater than 5.45 are most likely of malignant nature (Marghoob & Jaimes, 2015).

Score range	Criteria		Points	Multiply points by factor	Final dermoscopy score range
0-2	Asymmetry	No asymmetry	0	X 1.3	0-2.6
		Mono-axial asymmetry	1		
		Bi-axial asymmetry	2		
0-8	Border	No sharp border	0	X 0.1	0-0.8
		One segment with sharp border	1		
		Two segments with sharp border	2		
		Three segments with sharp border	3		
		Four segments with sharp border	4		
		Five segments with sharp border	5		
		Six segments with sharp border	6		
		Seven segments with sharp border	7		
		Eight segments with sharp border	8		
1-6	Color	White	1	X 0.5	0.5-3
		Red	1		
		Light Brown	1		
		Dark Brown	1		
		Blue-gray	1		
		Black	1		
1-5	Dermoscopic structure	Network	1	X 0.5	0.5-2.5
		Aggregated globules	1		
		Dots	1		
		Structureless areas	1		
		Branched streaks	1		
Final dermoscopy score range					1-8.9
Final dermoscopy score: < 4.75 = benign; 4.75-5.45 = suspicious; > 5.45 = malignant					

Figure 4. ABCD method of dermoscopy. Reprinted from Journal of the American Academy of Dermatology, 30/4, Nachbar et al., The ABCD rule of dermatoscopy: High prospective value in the diagnosis of doubtful melanocytic skin lesions, 551-559, 1994, with permission from Elsevier.

Menzies Method

Menzies method was created to assist in differentiating melanomas from other pigmented skin lesions with an overall sensitivity of 92% and a specificity of 71% (Menzies, Ingvar, Crotty, & McCarthy, 1996). Lesions are evaluated based on the presence of positive criteria and the absence of negative criteria. Negative criteria include a symmetrical lesion and the presence of only one color. Lesions that possess both negative criteria are essentially negative for melanoma, as these features together have zero percent sensitivity for melanoma. Positive criteria include dermoscopic features such as a blue-white veil, multiple brown dots, pseudopods, radial streaming, broad network, scar-like depigmentation, peripheral black dots or globules, multiple blue/gray dots and five or more colors within the lesion. The presence of any one of these positive criteria causes suspicion for melanoma (Marghoob & Jaimes, 2015).

Seven-point Checklist

Major and minor criteria constitute the seven-point checklist. All criteria are commonly associated with melanoma. Major criteria include an atypical pigment network, blue-white veil, and atypical vascular pattern. Minor criteria include irregular streaks, blotches, dots or globules, and regression structures. Major criteria are worth two points and minor criteria are worth one point each, with a score greater than or equal to three representing high suspicion for melanoma (Walter et al., 2013).

Three-point Checklist

The three-point checklist is a condensed version of the previous algorithms and is designed for use by providers practicing in the primary care setting. Originally, this method was created for non-experts in dermoscopy to use as a screening tool to aid the identification of melanoma and pigmented basal cell carcinoma. Three dermoscopic criteria are evaluated by this

method: asymmetry and dermoscopic structures, atypical network, and blue-white structures.

One point is scored for each criterion present within the lesion and an overall score of two

warrants a biopsy or referral for evaluation by a specialist (Marghoob & Jaimes, 2015).

Criteria	Definition	Score
Asymmetry	Asymmetry in distribution of dermoscopic color and/or structures in one or two perpendicular axes. The contour or silhouette of the lesion does not factor into whether the lesion is symmetric or not	1
Atypical pigment network	Pigment network with thick lines and irregular holes	1
Blue-white structures	Blue-white veil and/or white scar-like depigmentation and/or blue pepper-like granules	1
Interpretation: A total score of 2 or 3 points is considered positive, and the skin lesion should be removed or submitted for further evaluation		

Figure 5. Three-point checklist of dermoscopy. Copyright © 2004 Karger Publishers, Basel, Switzerland.

Pattern Analysis

Pattern analysis is considered one of the more complex methods of dermoscopic examination because it uses a template which requires the provider to have previous knowledge of dermoscopic patterns of benign nevi and melanoma. This method has high specificity among experienced providers, but may have an overall worse diagnostic accuracy than naked eye skin examinations when used by non-expert providers, 79-88% and 61-79%, respectively. Sensitivity for pigmented melanoma using this method ranges from 82 to 85% (Marghoob & Jaimes, 2015).

Patterns, networks and vascular structures are evaluated in depth and are associated with numerous diagnostic possibilities based on either the presence or absence of melanoma-specific features and benign patterns.

Limitations

Due to the complex nature of dermoscopy, limitations may exist in the diagnostic accuracy among healthcare providers based on their knowledge and experience of the practice. A

minimal amount of training is required to see advantages of dermoscopy over other techniques. Up to three years of practice is typical before providers feel confident in their dermoscopic skills, versus a brief module or one-day training course as previously noted.

Dermoscopy alone is not recommended for the identification and diagnosis of cancerous skin lesions as it may fail to recognize cancerous lesions that lack certain dermoscopic features. Principal purpose for dermoscopy will vary depending on the clinical setting. For primary care purposes, dermoscopy is strongly recommended for the evaluation of pigmented and nonpigmented lesions to determine whether a lesion should be biopsied or further evaluated by a specialist (Marghoob & Jaimes, 2015).

Summary

Many algorithms exist in the practice of dermoscopy. Using simplified, yet sensitive and specific algorithms for the detection of melanoma and other skin lesions is recommended for those non-expert providers in primary care settings. Using dermoscopy along with clinical judgment and NEE has been shown to improve the diagnosis of melanocytic lesions. With a small degree of education and clinical practice, dermoscopy can be accurately utilized by healthcare providers in primary care settings.

CHAPTER THREE. THEORETICAL FRAMEWORK

Completing a professional practice improvement project involves guidance from chosen theories and models to facilitate changes into clinical practice. Evidence-based practice (EBP) is the process of using current best practice evidence to improve patient care. EBP is considered the cornerstone of clinical quality improvement and, “involves awareness of best available evidence and the ability to implement it” (Jones, 2013, p. 61). The Iowa model of EBP and the Diffusion of Innovation theory were selected to guide the project from start to finish.

The Iowa Model of Evidence-Based Practice

The Iowa model of evidence-based practice is an algorithm used to guide research intended to promote clinical change. The Iowa Model of EBP was developed by Marita G. Titler and her colleagues to describe knowledge transformation and act as a guide for the implementation of research into clinical practice (Melnyk & Fineout-Overholt, 2011). The model itself (APPENDIX B) outlines a pragmatic multiphase process of implementing a change with feedback loops for evaluation and reconstruction (Melnyk et al., 2011). Once a need for change is identified, a review and critique of literature is completed to identify research based evidence supporting the proposed change in clinical practice. This leads to the implementation of the selected change in practice followed by evaluation and dissemination of results. Guidance from the Iowa model of EBP will be used throughout the practice improvement project. Application of this model is further reviewed in subsequent paragraphs.

Topic Selection

Topics for EBP are selected either through identification of an existing clinical concern or from new knowledge not yet applied to clinical practice. Triggers for topic selection are either problem-focused or knowledge-focused. Problem-focused triggers explore existing data that

presents with areas for improvement and knowledge-focused triggers explore new research and guidelines to lead healthcare providers to question and change current standards (Melnik et al., 2011). Current skin examinations are not routinely completed and data suggests that primary care providers may not have adequate training to identify skin cancers (Curiel-Lewandrowsi, 2012). Dermoscopy aims to improve the incidence of overall skin examinations performed in primary care settings by offering new research demonstrating the benefits of its practice.

Team Formation

When forming a team, the co-investigator needs to address whether the topic is a priority for the organization involved. Once this is established, a team is formed to develop, implement, evaluate and sustain the practice change. Members of the team may include stakeholders from practice, nurses, interdisciplinary colleagues, topic experts and advanced practice providers. Committee members were selected based on these criteria and include: Dean Gross, PhD, FNP-BC, committee chairperson; Kelly Buettner-Schmidt, PhD, RN; Sheryll Clapp, FNP-BC, RN; Richard W. Blaine, MD; and Eugene Berry, PhD. Additional team members include other healthcare professionals (nurses, support staff) at the NDSU Student Health Center.

Evidence Retrieval

Evidence retrieval starts with the identification of available resources and key terms. Scholarly databases are used to collect evidence from a variety of sources and viewpoints (Melnik et al., 2011). Information gathered thus far includes incidence, prevalence, and pathophysiology of various skin lesions, current skin cancer screening techniques, and the implications and practice of dermoscopy. Textbooks, electronic databases, and healthcare professionals contributed to the collection of evidence.

Evidence Grading

Critique and synthesis of previously retrieved evidence occurs by the team to address the quality of research and the strength of the body of evidence overall (Doody & Doody, 2011). Evaluation of the effectiveness, appropriateness and feasibility of each piece of evidence is completed at this stage in the Iowa model. Sufficient evidence must be present to develop a comprehensive EBP change. Evidence gathered thus far represents both qualitative and quantitative data on skin cancer screening in primary care and the practice of dermoscopy.

EBP Standard Development

Following critique of the literature, recommendations for practice are created. Recommendations address practice guidelines, assessments, actions, and treatments while considering relevance, meaningfulness, and effectiveness for practice (Doody & Doody, 2011). Objectives for this project focus on the development of a dermoscopy teaching resource, expansion of provider knowledge, and confidence in performing dermoscopic skin examinations and sustainability of the practice of dermoscopy with the NDSU Student Health Center.

EBP Implementation

Implementation occurs over a designated time period of direct interaction between the direct care providers, the facility, and those in leadership roles to support clinical practice changes (Doody & Doody, 2011). Support for implementation of the project is crucial as social and organizational factors may affect the integration of evidence into the clinical practice setting.

Evaluation

Evidence-based practice changes need ongoing evaluation in order to promote integration of the change into a clinical setting (Melnik et al., 2011). Evaluation methods should include audits and feedback loops to promote success and sustained integration of the practice change.

Statistical analysis of pre- and post-surveys along with personal interviews will be the mainstays for evaluation for the co-investigator's project.

Summary

Using the Iowa Model as a guideline for project implementation will contribute to the success and sustainability of this practice improvement project. Evidence-based practice is, “a pathway to excellence and has now become an expectation of healthcare professionals” (Steelman, 2016, p. 5). Recognizing the EBP behind dermoscopy provides a solid foundation for not only implementation, but also continued research and clinical application of future ideas within the field of screening for skin cancer in primary care.

Diffusion of Innovation Theory

The Diffusion of Innovation (DOI) Theory was developed by E. M. Rogers in 1962 as a tool to help disseminate health behavior changes into clinical practice settings. The theory framework describes the process of innovation and the several stages involved in adopting a new idea, which narrows the gap between what is known and what is put to use (Pender, Murdaugh & Parsons, 2011). Guidance from this theory will be used to increase the incidence of skin cancer screenings by filling the knowledge gap surrounding the practice of dermoscopy.

Diffusion

Multiple factors are involved in the diffusion of knowledge into clinical practice. Diffusion, “has been defined as the process through which an innovation is communicated through certain channels, over time, among members of a social system” (Pender et al., 2011, p. 76). Four main elements make up this process; innovation, communication channels, time and a social system (Boston University School of Public Health, 2016). Innovation is defined as an idea or practice that is considered new by the individuals involved. Dermoscopy represents the

innovation in this practice improvement project. Communication channels represent the process by which the involved individuals create and share information pertinent to the chosen innovation (Rogers, 1997). In this practice improvement project, face to face communication, structured interview questions, standardized survey questions and an educational resource represent the main components of communication.

Time is involved throughout the spread of diffusion at numerous points. The time it takes for individuals to recognize, process and adopt the planned innovation depends on a multitude of factors and occurs on a continuum rather than all at once (Pender et al., 2011). For this project, time has been allowed for the involved individuals to recognize dermoscopy as a desired innovation by setting a three-month long implementation period. Future steps of the project will measure the degree and rate to which dermoscopy is adopted by healthcare providers at the NDSU Student Health Center. The social system is defined as, “a set of interrelated units that are engaged in joint problem-solving to accomplish a common goal” (Rogers, 1997, p. 2). Healthcare providers at the NDSU Student Health Center comprise the engaged social system described in the DOI theory. These providers have expressed interest towards improving their knowledge and clinical practice of dermoscopy.

Qualities of Innovation

Adoption of the proposed innovation is the end point recognized in the DOI theory. Characteristics explaining the adoption of an innovation include relative advantage, compatibility, complexity, trialability, and observability (Pender et al., 2011). Relative advantage is whether the members of the social system perceive the innovation as advantageous. The greater the perceived advantage of the innovation directly relates to how quickly it will be adopted into clinical practice. Compatibility describes how well the innovation fits with the

values, norms, and goals of the selected social system. Currently, healthcare providers at the NDSU Student Health Center attend conferences on the practice of dermoscopy and voice interest in pursuing the practice at a greater depth. The speed at which an innovation is adopted also depends on its complexity. On average, two to three years pass before providers consider themselves comfortable with dermoscopy. Overall, the practice of dermoscopy is quite complex because of the number of variables within each unique skin lesion. Because of the desired need for dermoscopy by providers at NDSU student health, the project coordinator hopes this higher degree of complexity is a factor that has already been recognized and accepted by the social system. A slower, yet steady degree of adoption of the practice of dermoscopy is anticipated.

Trialability refers the extent to which an innovation can be practiced on a limited basis (Pender et al., 2011). Innovations that can be tried in installments tend to be adopted more rapidly than innovations that cannot be divided. Learning to identify skin lesions with a dermatoscope, although complex, can and should be broken into pieces to teach healthcare providers a systematic approach. By providing an educational resource and demonstration that breaks down the practice of dermoscopy into practical sections, this project follows the guideline of the DOI theory involving trialability. Lastly, observability is the degree to which the results of an idea are noticeable to others (Rogers, 1997). An innovation is adopted more quickly if members of the social system and related audiences can easily see the results. Dermoscopy provides a detailed picture of skin lesions from which direct action can be taken; i.e. dermatology referral, biopsy, close monitoring or decision that the lesion is benign. This outcome will be observed by both the NDSU providers and the patients they implement dermoscopy upon. Both audiences will be directly exposed to the results of dermoscopy.

Adopter Categories

Adoption of an innovation depends upon the aforementioned variables as well as the rate at which individuals adopt the proposed idea. There are five adopter categories listed in the DOI theory; innovators, early adopters, early majority, late majority, and laggards (Pender et al., 2011). Innovators actively seek out new information and are not intimidated by high levels of uncertainty or change. These individuals are first to adopt a new idea into clinical practice. Early adopters hold the highest degree of leadership within a social system, therefore making them the people to consult with prior to adopting the innovation. Early majority comprises one third of people and refers to individuals who deliberate before adopting an innovation. People in this category rarely lead the adoption of a new idea. Late majority also comprises one third of people, but it includes those who have reservations about the proposed innovation. People in this category often adopt an idea only after pressure from peers or when they determine it is safe to adopt the change. Laggards tend to be highly suspicious of change, therefore must confirm the success of the innovation prior to adopting. Individuals who fall into the laggard category tend to slow the rate of innovation diffusion. Targeting the categories with the largest populations, specifically the early adopters will assist in timely adoption and presumed sustainability (Pender et al., 2011).

Summary

Overall, the DOI theory focuses on describing the adoption rates of innovations by specific individuals and targeting the appropriate adopter group for optimum integration of an innovation. Identification of certain adopter groups and techniques to implement change within these groups will be paramount to the success of this project.

CHAPTER FOUR. PROJECT DESCRIPTION

Congruence of the Project to the Organization's Strategic Plan/Goals

This practice improvement project was implemented at the NDSU Student Health Center. The entirety of the project aligned with the mission of this organization, which is to provide members of NDSU with access to quality and effective healthcare (NDSU, 2015). Prior to this project, healthcare providers at this organization had expressed interest in exposure to more education and experience using dermoscopy to examine skin lesions on patients. Providers had also mentioned that patients have shown an increased interest in skin screenings over the past few years. Using NEE in combination with dermoscopy intended to increase provider confidence, improve knowledge of dermoscopy and accurate identification of skin lesions as well as increase patient satisfaction.

Project Objectives

Project objectives identified for successful implementation of this dissertation were aimed at creating, educating and applying knowledge of the practice of dermoscopy to the healthcare providers at the North Dakota State University Student Health Center. Objectives included:

- 1) Develop and implement an educational resource regarding the clinical application of dermoscopy at the NDSU Student Health Center.
- 2) Improve knowledge among the primary care providers practicing at the NDSU Student Health Center on the clinical appearance and identification of both benign and malignant skin lesions under dermoscopy.
- 3) Promote utilization and sustainability of the clinical use of dermoscopy in the primary care setting by providing a copy of the educational resource and supplemental

references for the primary care providers practicing at the NDSU Student Health Center.

Project Design

Design of this practice improvement project was aimed at improving knowledge of dermoscopy via educational resources and clinical application at the NDSU Student Health Center. Until recently, the NDSU Student Health Center did not possess a dermatoscope. Healthcare providers at NDSU had previously completed skin examinations via a pen light and a magnifying glass or with a naked eye. Interest in dermoscopy was expressed by some of the providers, specifically Sheryl Clapp, to the co-investigator and a few of them had attended conferences where beginner sessions on the practice of dermoscopy were hosted. With the new possession of a dermatoscope within the clinic, providers can apply current knowledge of dermoscopy to patient scenarios to enhance skills associated with the practice of dermoscopy. This project aimed to assist in the development and improvement of skills associated with the practice of dermoscopy.

This project allowed for the improvement of provider knowledge of dermoscopy through education provided by the project coordinator and through clinical application. The combination of education with clinical practice intended to maximize the potential for providers to improve their dermoscopy practice. Herschorn (2012) confirms this teaching technique through studies indicating improved provider dermoscopic skills after exposure to a one day dermoscopy course accompanied by supplemental reference material.

An important portion of this practice improvement project was focused on providing an educational resource along with a demonstration in the practice of dermoscopy to NDSU healthcare providers. The co-investigator hosted one, two-hour session to present education and a

demonstration of dermoscopy techniques. Dermatoscopes, a power-point presentation, laminated educational resource, skin cancer handouts, and dermoscopy textbook were presented during the session. Healthcare providers were able to practice using the dermatoscopes along with the algorithms presented in the session. Specific topics presented during the educational session included, general skin cancer education, dermoscopy of darker skin tones, most common skin lesions seen in primary care clinics, and algorithms denoting recommendations for further management of suspicious skin lesions.

Materials for the educational resource and demonstration included photographs of skin lesions, both with a naked eye and under dermoscopy, and straightforward algorithms to utilize in lesion identification. Of the algorithms discussed previously, the three-point checklist and the ABCD rule of dermoscopy were reviewed and demonstrated. These specific algorithms were chosen by the co-investigator due to their simplicity, ease of application for lesions seen in primary care settings, and research supported efficacy.

Once education had been provided to the staff at the NDSU Student Health Center, two dermatoscopes were loaned to the clinic for practice, in addition to the dermatoscope already available at the clinic. The co-investigator used a three-month period during which the providers had the opportunity to practice and improve their dermoscopy skills. Dermoscopy examinations were offered to patients presenting with any skin concern and those presenting for annual physical examination. The dermatoscopes were in a central location to allow access for any NDSU provider to use with their patients. Throughout the three-month implementation period, the co-investigator made three informal visits to Student Health Services to visit with providers about the progress of their dermoscopy experience and answer any questions.

Prior to the start of this project, providers were asked to complete a pre-survey (APPENDIX E) to assess current knowledge level and comfortability level with dermoscopy. At the completion of the three-month implementation period, a post-survey (APPENDIX F) assessing the similar topics was administered on a voluntary basis for providers to complete.

Pre-and post-surveys evaluated provider responses to questions using a Likert scale format. Survey questions addressed the providers' thoughts on the practicability of dermoscopy, personal knowledge before and after the implementation of the project, comfortability with dermoscopy, and implications for the future. Surveys were administered with the use of a program called Qualtrics, and were completely electronic. Data analysis was completed using Qualtrics features to analyze and report on final data points at the conclusion of the project.

Project Resources

Resources needed to implement this practice improvement project included time, location, healthcare personnel, technology, and financial means. Approval from the NDSU Student Health Center (APPENDIX C) was granted for implementation of this project. Seven healthcare providers employed by NDSU were the key stakeholders in the success and sustainability of this project. Additional personnel included the coordinator, practice improvement project committee members, healthcare professionals (providers and nurses), and specific patients who provided their consent for participation. One committee member, Sheryll Clapp, is also a provider at the NDSU Student Health Center. This connection maintained alignment of this coordinator's project with the goals and needs of the healthcare providers at NDSU.

A major resource was the creation of an educational resource and demonstration in dermoscopy. This educational resource was created using textbooks, online resources, electronic

applications and recommendations from specific committee members who have had experience with dermoscopy. Permission to use excerpts from dermoscopy resources was sought prior to the creation of the education resource. Permission from multiple online resources for reproduction of images was also granted. The created resource is a three-ring binder consisting of color photographs and teaching points identifying key elements in various skin lesions. It intended to walk providers through the three-point checklist and ABCD rule of dermoscopy, as explained above, to assist in distinguishing suspicious lesions and melanomas from other benign pigmented skin lesions. Along with the resource, the co-investigator created a single page, color handout discussing the prevalence, risk factors, and prevention of skin cancer (APPENDIX L). Fifty color copies were printed and given to the providers at Student Health Services to hand out to patients during the implementation period. Sample size packets of sunscreen were attached to each handout.

Additionally, the co-investigator loaned personal textbooks regarding dermoscopy to the NDSU providers throughout project implementation as supplementary resources. The NDSU Student Health Center has one dermatoscope, and the NDSU School of Nursing has two additional dermatoscopes that were available for the co-investigator and providers to use throughout the project.

Funding for this project included costs for the creation of an educational resource, specifically cost of textbooks, online applications, color printing, and miscellaneous office supplies. The total cost for these materials was relatively small.

Technological resources for the implementation of this project included computers with internet access to view online documents, electronic mail, and dermoscopy resources. One major

resource was the use of dermatoscopes, which were used extensively throughout the entirety of the practice improvement project.

Project Evaluation

Evaluation of this practice improvement project assessed if the defined objectives were met. A logic model was used to display the inputs, activities, outputs, short term outcomes and long term outcomes in a diagram to highlight the elements involved within the defined objectives. Evaluation of each defined objective is elaborated on in subsequent paragraphs.

Objectives

- 1) Develop and implement an educational resource regarding the clinical application of dermoscopy at the NDSU Student Health Center.

The development of an educational resource involved a demonstrational session of evidence based practice techniques for the practice of dermoscopy in a primary care setting. Evaluation of this education was completed through analysis of pre-and post-surveys. Pre-and post-surveys contained questions directed at the quality and practicality of the education provided.

- 2) Improve knowledge among the primary care providers practicing at the NDSU Student Health Center on the clinical appearance and identification of both benign and malignant skin lesions under dermoscopy.

Education regarding the identification of benign and malignant skin lesions was provided through an educational resource and clinical practice with dermoscopy. Improvement was evaluated based on unique provider responses to pre-and post-survey questions using a Likert scale to address knowledge and comfortability changes over the course of implementation of this practice improvement project. Informal question and answer opportunities during the informal

visits were used to further evaluate provider opinions of their experience using dermoscopy and their gaps in knowledge. The co-investigator understood varied responses of improvement based on the differences in current level of experience from one provider to another.

- 3) Promote utilization and sustainability of the clinical use of dermoscopy in the primary care setting by providing a copy of the educational resource and supplemental references for the primary care providers practicing at the NDSU Student Health Center.

Likert scale survey questions were used to evaluate the practicality and future utilization of dermoscopy through questions aimed at provider opinions of sustainability. Continued practice and exposure to dermoscopy is crucial in the improvement of dermoscopic skills, thus providing copies of educational resources for the NDSU providers to use alongside a dermatoscope, met this objective for continued utilization and sustainability.

Recommendations for an appropriate dermatoscope for any provider interested in purchasing a personal instrument was provided based on information gathered from medical supply websites, provider reviews and content from databases containing information on dermoscopy. For the purposes of this practice improvement project, either a polarized or a non-polarized dermatoscope with ten-fold magnification capabilities was appropriate. One contact, non-polarized recommendation is the EpiScope Skin Surface Microscope produced by Welch Allyn (APPENDIX G-I). Features include illumination and ten-fold magnification, autoclavable contact plate with measurements etched on plate and a power source that fits any standard Welch Allyn product. Cost of this dermatoscope was approximately 500 dollars and came with a one-year warranty (Welch Allyn, 2015).

A non-contact polarized option for healthcare providers is the DermLite DL100 pocket epiluminescence microscopy device (APPENDIX J-K). Features include bright-white, natural illumination, a 10x lens, and advanced cross-polarization technology for greater visualization of vascular structures, pigmented lesions, and contrasting colors. Cost of this dermatoscope was approximately 375 dollars and came with a five-year warranty (DermLite, 2017).

Evaluation Model

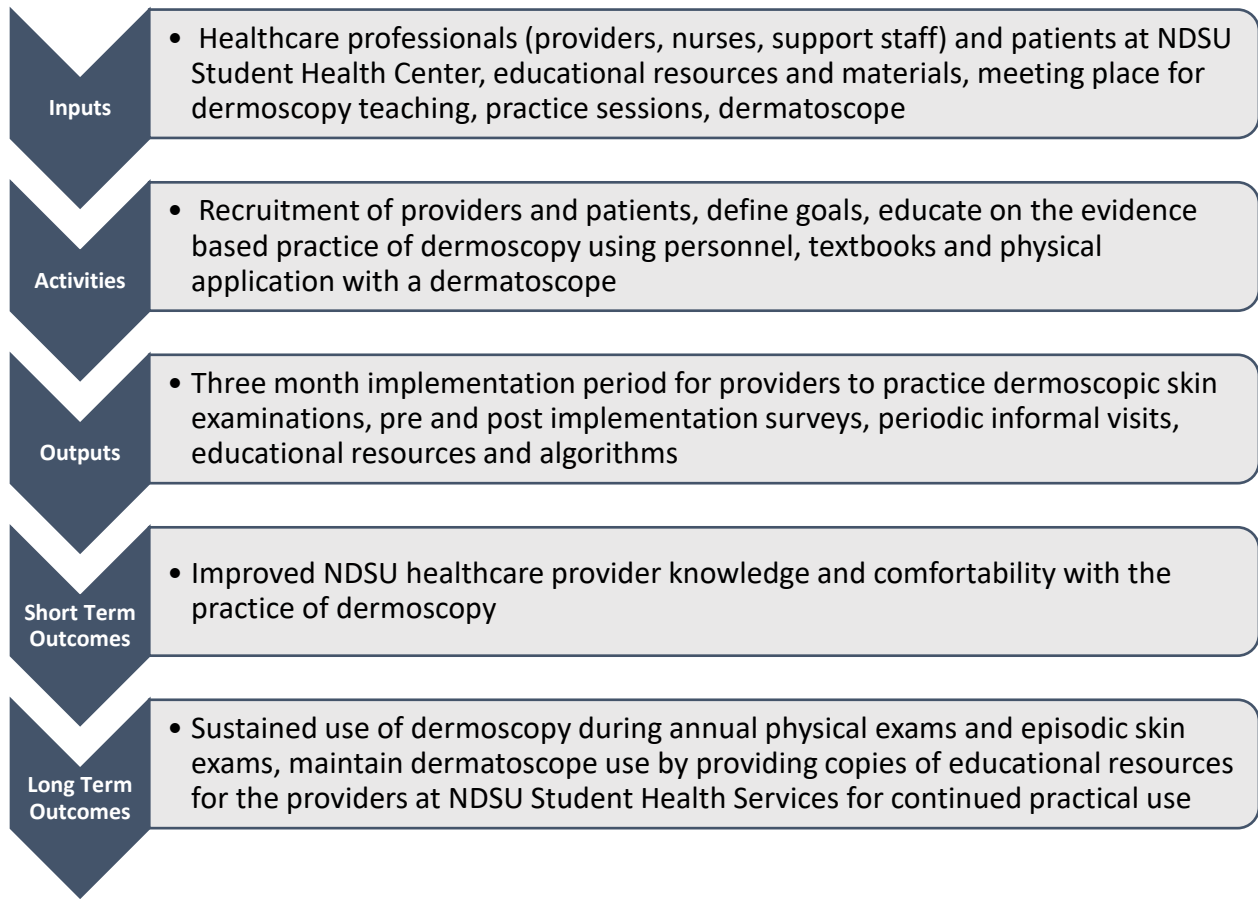

Figure 6. Logic model for practice improvement project objectives.

Protection of Human Subjects

The human subjects involved in this project include healthcare providers, nurses and students who visit NDSU Student Health Services. This project included both students who visit

the clinic for skin lesion concerns and those who present for annual physical visits. Students presenting for annual physical examinations were educated by the healthcare provider regarding dermoscopy and then had the choice to have a skin screening completed using dermoscopy if desired. For the purposes of this project, no special precautions were taken to include or exclude women and minorities. Because this project was implemented in a clinic designed for patients attending college, children were not involved within the entirety of the project.

The design of this project was intended for healthcare providers to increase their knowledge and comfortability regarding dermoscopy, which correlates with little to no risk for these healthcare providers. However, one potential risk on the providers' behalf included the additional time spent with each patient who consents to having a full skin screening completed with dermoscopy. Dermoscopy itself is painless, but patients may experience some discomfort since minimal clothing is recommended to perform thorough full body skin examinations. Patients may potentially experience some psychological distress if a skin lesion is identified as worrisome by the primary care provider and requires further work-up or referral to dermatology. Further exam by dermatology may place financial stress on specific patients depending on interventions proposed by the dermatology team.

Participants were all affiliated with NDSU Student Health Services and participation was completely voluntary for healthcare providers, nurses and patients. Participants on the student level included patients who presented with skin concerns and/or for their annual physical exams. Verbal informed consents, explanation of voluntary involvement and provider discretion for dermoscopy screening implementation was emphasized throughout this practice improvement project. Pre-and post-implementation surveys and project evaluation forms were voluntary for healthcare providers to complete as well.

Potential benefits of this proposed practice improvement project include increased knowledge and comfortability among healthcare providers regarding the practice of dermoscopy, an increase in the incidence of skin cancer screenings done in primary care settings, and an improvement in the overall quality of life of patients. Using a combined approach of dermoscopy and NEE to examine skin provides an approximately 20% increase in sensitivity and specificity in identification of benign versus malignant lesions, potentially decreasing overall mortality.

CHAPTER FIVE. RESULTS

The project described above was initiated on August 17th, 2016 and concluded on November 17th, 2016 at North Dakota State University Student Health Services. The project population included only healthcare providers at NDSU Student Health Services. The total number of participants was seven. Of the seven healthcare providers, seven responded to the pre-implementation survey and three replied to the post-implementation survey. Surveys were administered prior to the start date of the implementation period and then again after the conclusion of the three-month implementation period. Surveys were only administered to healthcare providers at NDSU Student Health Services, no students, patients, or other individuals were involved. Survey participation was completely voluntary for healthcare providers.

Sample Demographics and Data Analysis

All healthcare providers involved in this practice improvement project were female and were employed by NDSU. Among the healthcare providers, there were six nurse practitioners and one medical doctor. The average experience among providers ranged from ten years to greater than 25 years, with the average around 15-20 years of healthcare provider experience.

Data analysis of the healthcare providers' pre-and post-implementation surveys were done electronically through a program called Qualtrics. Pre-and post-surveys were administered via email and reports were displayed within Qualtrics. Reports from Qualtrics include bar graphs listed below, as well as percentages determined for each answer for each question on both the pre-and post-implementation surveys.

Data Results

To recap, the project objectives included 1) developing and implement an educational resource regarding the clinical application of dermoscopy at the NDSU Student Health Center;

2) improving knowledge among the primary care providers practicing at the NDSU Student Health Center on the clinical appearance and identification of both benign and malignant skin lesions under dermoscopy; and 3) promoting utilization and sustainability of the clinical use of dermoscopy in the primary care setting by providing a copy of the educational resource and supplemental references for the primary care providers practicing at the NDSU Student Health Center.

Survey data was quantitative in nature and included a five-point Likert scale with response choices of *strongly agree*, *agree*, *disagree*, and *strongly disagree*. A total of four Likert scale questions were asked. Seven of the seven providers fully completed the pre-implementation survey, while three of the seven fully completed the post-implementation survey. Three bar graphs have been included within the following pages to represent the separate data obtained from the pre-and post-implementation surveys. The answers to the Likert scale portion of both the pre-and post-implementation surveys are given below:

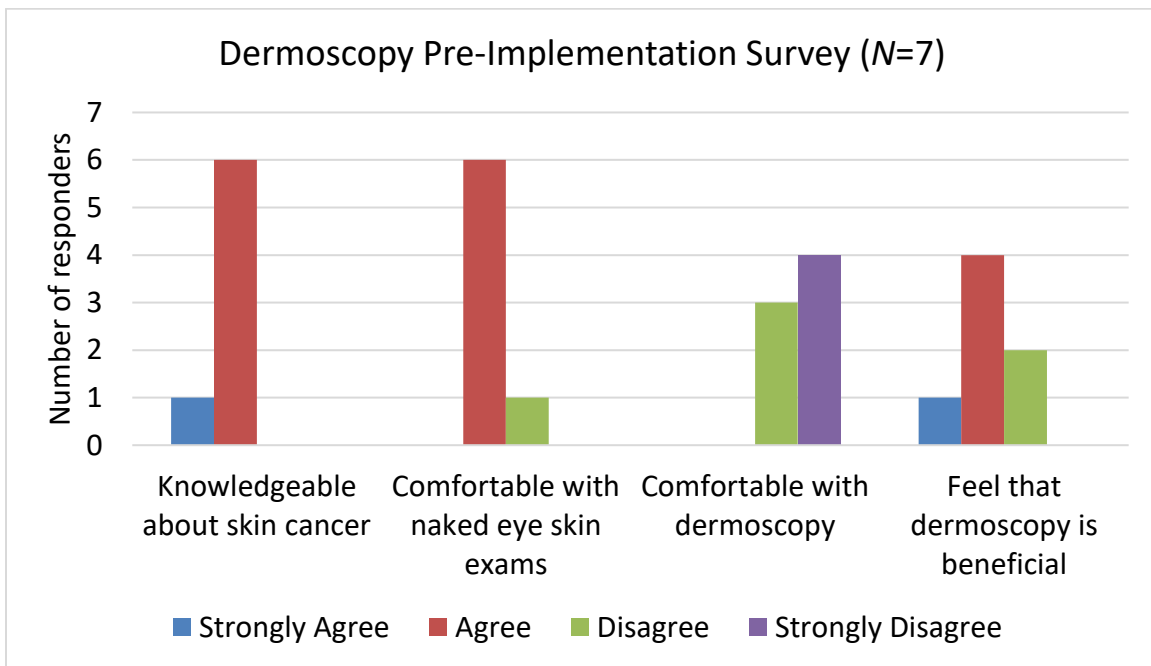

Figure 7. Dermoscopy pre-implementation survey results.

Statement One

I am knowledgeable about skin cancer prevalence and prevention strategies. This statement was created to establish a base of knowledge among providers on the general topic of skin cancer prior to delving into the more complex topic of dermoscopy. On both the pre-and post-implementation survey, all the responders agreed, with one strongly agreeing with the statement.

Statement Two

I feel comfortable performing naked eye skin examinations. Statement two was designed with similar intentions as statement one; assessing baseline comfortability among providers with a naked eye skin examination as this is critical to the practice of dermoscopy. On the pre-implementation survey, six responders agreed with the statement and one responder disagreed. On the post-implementation survey, all (three) of the responders agreed with the statement.

Statement Three

I feel comfortable with the practice of dermoscopy. Purpose of this statement was to gather a sense of provider comfortability prior to and following the dermoscopy demonstration and implementation period. On the pre-implementation survey, three responders disagreed with the statement and four strongly disagreed. On the post-implementation survey, two responders agreed with the statement and one responder disagreed.

Statement Four

I feel that using dermoscopy will benefit my practice and my patients. Statement four was created to establish value of the project goals to each of the providers involved. Four responders agreed with the statement, one strongly agreed and two disagreed with the statement on the pre-

implementation survey. On the post-implementation survey, all responders agreed with the statement, with one responder strongly agreeing.

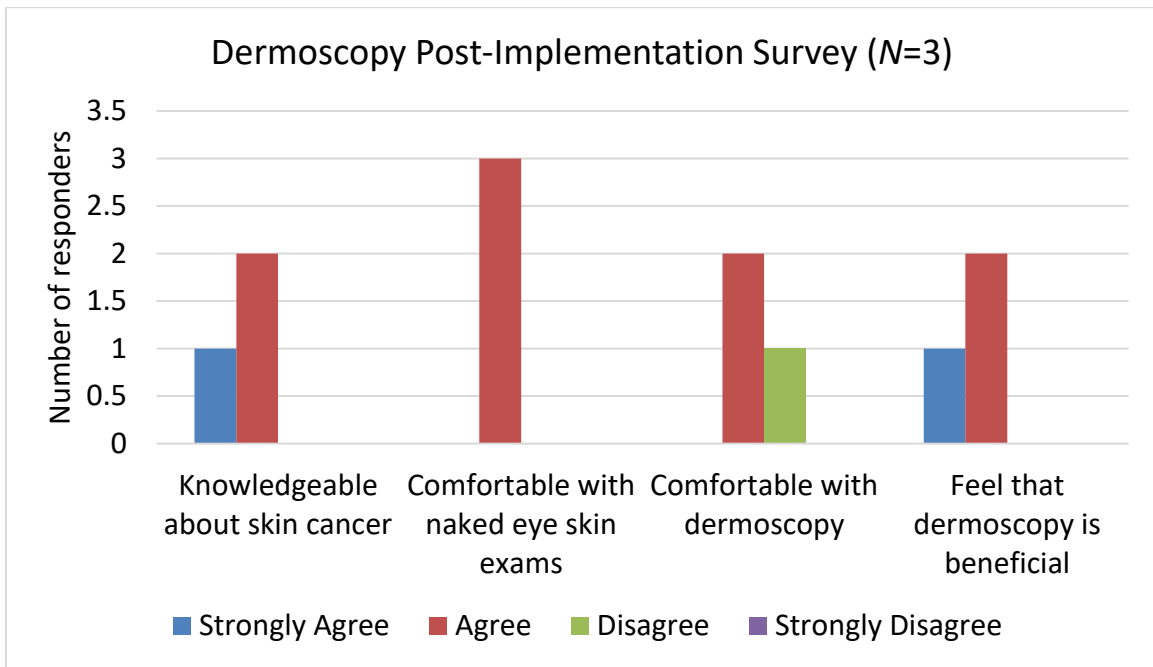

Figure 8. Dermoscopy post-implementation survey results.

One survey question also included a scale rating comfort level with response choice of novice, advanced beginner, competent, proficient, and expert. A total of one survey question using this scale was asked. Again, seven of seven providers responded to this question on the pre-implementation survey and three of the seven responded on the post-implementation survey.

The answers to the question are given below:

Question One

What do you consider your current level of knowledge of dermoscopy? Intention of this question was to ascertain each provider's level of knowledge of dermoscopy before and after the implementation of the project to assist in establishing benefit from the project. Five of the responders considered themselves as a novice in the practice of dermoscopy and two responders

considered themselves advanced beginners on the pre-survey. On the post-implementation survey, two responders replied with novice and one responder replied with advanced beginner.

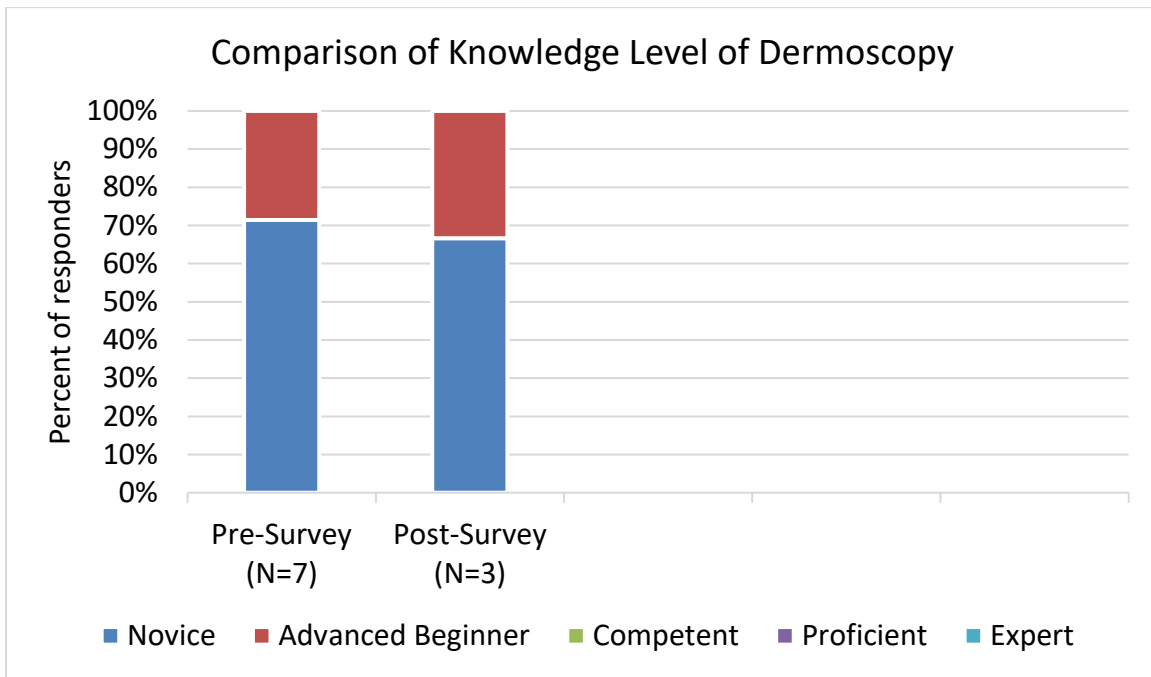

Figure 9. Comparison of dermoscopy pre- and post-implementation survey results.

One final space for responders to supply any additional comments, questions or feedback was provided on the post-implementation survey only. The question was open ended in nature and was completed by two of the three responders who completed the post-implementation survey. Qualitative responses are given below:

Question Two

If you have any additional comments, questions, or feedback, please list below.

Responses included, “The dermascope and additional training has been helpful to my practice” and “Not had a lot of students to practice this skill on but appreciate the information!!”

CHAPTER SIX. DISCUSSION AND RECOMMENDATIONS

Skin cancer is one of the most common types of cancer, with millions of individuals affected each year. Screening for skin cancer however, is one of the lowest routine screenings completed by healthcare providers in the primary care setting. Documented prevalence of skin cancer screenings by a healthcare provider occur only about 8% to 21% of the time during annual physical examinations (Curiel-Lewandrowski et al., 2012). The main goal of screening for skin cancer is to identify lesions suspicious for skin cancer, especially melanoma.

Research has identified that one of the main reasons for low skin cancer screening rates is an inconsistent method for screening (Herschorn, 2012). Healthcare providers who have been educated regarding the practice of dermoscopy, even educational seminars lasting one day, have demonstrated increased accuracy in identifying melanoma through the application of diagnostic dermoscopic algorithms. The benefit of a one day dermoscopy seminar combined with educational materials provides sufficient information for healthcare providers to successfully practice dermoscopy for at least 16 months after the training day, if they remain exposed to dermoscopy in practice (Herschorn, 2012).

Introducing dermoscopy and specific methods of dermoscopy application to healthcare providers intended to break down this barrier associated with skin cancer screenings. Providing education on the practice of dermoscopy and screening algorithms to NDSU providers aimed to offer a concrete and evidence-based method of skin cancer screening. By providing education and opportunity for clinical application of dermoscopy, additional intent was to increase healthcare providers' confidence in identifying and monitoring skin lesions with a dermatoscope within the primary care setting.

Quantitative Results and Interpretations

Inferences from the results of the Likert scale pre- and post-surveys are made with caution since this was a small, convenience sample with a low response rate. Of the seven responders who completed the pre-survey, three of those responders completed the post-implementation survey. Cunningham et al. (2015) explored response rates in healthcare provider groups which revealed an overall low response rate spanning across family practice providers and numerous specialty practice providers. Family practice providers specifically showed a response rate of 40.1% compared with specialists, who had a response rate of 49.6% (Cunningham et al., 2015). Survey response rates were most influenced by monetary incentives, specifically smaller incentives for each responder compared with a large, one-time lottery draw. Reasons providers did not complete surveys, according to the article, include survey burden and a lack of time to complete requested surveys (Cunningham et al., 2015). The co-investigator created pre-and post-surveys with time in mind by limiting the surveys to less than ten questions and providing Likert scale answers. Future recommendations may include the addition of small monetary incentives for those providers who complete both surveys.

Data from the three responders who completed both the pre- and post-implementation surveys displays common themes. On the pre-survey, approximately 28.57% of responders disagreed that the practice of dermoscopy will benefit their practice and patients. Post-survey responses show that 100% of responders now agreed with the same statement, with 33.33% strongly agreeing. This indicates the subjective usefulness of the practice of dermoscopy to both healthcare providers and patient care.

Additional inferences from the data demonstrate the increase in comfortability with not only the practice of dermoscopy, but also the practice of performing naked eye skin

examinations. Approximately 14.29% of responders disagreed with the statement that they feel comfortable performing naked eye skin examinations and 100% of responders either disagreed or strongly disagreed with the statement that they feel comfortable with the practice of dermoscopy on the pre-survey. Post-survey responses show that 100% of responders agree with the statement that they feel comfortable performing naked eye skin examinations and 66.67% agree with the statement that they feel comfortable with the practice of dermoscopy. Post-survey results also show that 33.33% of responders disagree with the statement indicating they feel comfortable with the practice of dermoscopy.

Lastly, data analysis on the healthcare providers' comfort level with the practice of dermoscopy slightly increased from pre- to post-implementation survey. Approximately 71.43% of responders considered themselves a novice at the practice of dermoscopy and 28.57% considered themselves an advanced beginner. Post-survey results show these numbers as 66.67% and 33.33%, respectively.

Qualitative Results and Interpretations

Due to the small number of healthcare providers who responded to the post-implementation survey and completed the one question aimed at gathering qualitative information, minimal data can be analyzed. Of the two responses, however, valid information was gathered displaying the achievement of the project objectives. Positive feedback was relayed within the two comments reported in the previous chapter, showing the meaningfulness of dermoscopy to both responders and their practice, despite one responder mentioning the limited amount of dermoscopy practice she had throughout the implementation period. Even with limited exposure to dermoscopy practice, both responders comment on the helpfulness and relevance of the information presented alone.

Advanced Practice Nursing Implications

The following paragraphs will discuss implications for future and current advanced nursing practice. Objectives of the project will be reiterated and examined. Advanced practice nursing aims to positively impact the health of society through excellence in nursing education, research, practice, and service (NDSU, 2016). Advanced practice nurses provide the most advanced level of nursing care for individuals, families, and communities, and serve as experts in leadership and in clinical roles.

Objective One

The first objective of this project was to develop and implement an educational resource regarding the clinical application of dermoscopy at the NDSU Student Health Center. Because this objective was the co-investigator's responsibility to complete, there was no direct data collected on this objective alone. This objective was completed before August 17th, 2017 when the educational resource was presented to primary care providers at NDSU Student Health Services. Contained within the educational resource were color photographs of varying skin lesions, dermoscopy algorithms with numerous examples, and population specific skin lesion examples. Furthermore, a color handout of facts and prevention techniques on skin cancer was created for healthcare providers to distribute to patients. Even without obtaining direct data pertaining to the created educational resource, qualitative data suggests that the presented information served as a strong guide for responders in the clinical application of dermoscopy.

Objective Two

A second goal of this project was to improve the knowledge among primary care providers practicing at the NDSU Student Health Center on the clinical appearance and identification of both benign and malignant skin lesions under dermoscopy. Per quantitative data

discussed above, this goal was met. By the conclusion of the project, the number of responders who considered themselves novices in the practice of dermoscopy decreased and the number of responders who considered themselves advanced beginners increased. From speaking with the healthcare providers during the visits made throughout the implementation period, the co-investigator feels that the provider group found this project to benefit their assessment of skin lesions both with and without the use of a dermatoscope. Positive comments were received regarding providers' personal assessment of their improved dermoscopy skills along with an increase in speaking to patients about skin cancer in general.

Additionally, healthcare provider comfort levels grew as evidenced by the increase in responders who felt comfortable with the practice of dermoscopy. Zero responders felt comfortable with the practice of dermoscopy on the pre-survey, and by the end of the implementation period 66.67% of responders replied that they felt comfortable with the practice of dermoscopy. By introducing a complex skill, such as dermoscopy, with straightforward and simple algorithms, provider knowledge and comfortability blossomed with the clinical application of dermoscopy.

Objective Three

Lastly, the final objective aimed to promote utilization and sustainability of the clinical use of dermoscopy in the primary care setting by providing a copy of the educational resource and supplemental references for the primary care providers practicing at the NDSU Student Health Center. Per survey responses directed at this goal, this objective was also met. The pre-survey shows two providers disagreed that the practice of dermoscopy would benefit their practice and their patients. Of these two providers, one did not complete the post-survey, but, the

one who did respond to the post survey, answered that now she believes the practice of dermoscopy will benefit her practice and her patients.

Project Limitations and Recommendations for Future Research

Project location included a sample size of seven healthcare providers. Sample size was chosen due to location, willingness of primary care providers to participate, and connection with the co-investigator to NDSU Student Health Services through a committee member. Of the sample size, 100% responded to the pre-implementation survey, and 42.8% responded to the post-survey. Reasons some providers chose not to participate were not provided, reasons provided by larger sources include survey burden, growing time constraints, and survey relevance, and benefit to each healthcare provider (Cunningham et al., 2015).

Another constraint of the project may have been the amount of clinical application of dermoscopy each provider received over the implementation period. Dermoscopy was offered to all patients who presented for their annual physicals or with any skin concerns. Due to this, the number of patients each provider could practice dermoscopy on was extremely variable. Per staff at Student Health Services, there were 4,858 total patient visits, with 324 (6.7%) of them being dermatology related, during the implementation period from August through November 2016. Further breakdown of this 6.7% of patients included those with general chief complaints of acne, burns, general rash, rash located in the groin, general skin concerns, general skin concerns related to the groin, or simple and complex wart removal. The above numbers only represent the number of visits with dermatologic concerns being the primary complaint, it does not reflect patients who incidentally brought up dermatologic concerns during visits associated with other primary complaints. No running total was kept of how many cases each provider used

dermoscopy with, but argument could be made that dermoscopy could be applied to each of the dermatologic complaints listed above.

National surveys show that in the United States in 2013, approximately 12.5% of outpatient ambulatory care visits included patients with dermatologic concerns (National Ambulatory Medical Care Survey, 2013). Frequently, at these visits, more than one dermatologic concern is addressed. One study showed that of all dermatologic issues encountered in primary care clinics, 41.5% were the chief complaint of the patient, 23.1% were a secondary concern, and 35.4% of dermatologic findings were noted during an examination and were not patient-directed (Lowell, Froelich, Federman, & Kirsner, 2001).

Additionally, 20% to 30% of all patients seen in a primary care clinic have at least one dermatologic issue among their list of complaints or medical history (Beroukhim, Nguyen, Danesh, Wu, & Koo, 2015). Because of the number of patients who either have a history of a skin concern or present with a new skin concern, the ability for primary care providers to competently complete skin examinations, with or without dermoscopy is paramount to correctly identifying skin lesions and managing accordingly.

Due to the above mentioned potential limitations, the co-investigator has identified areas of recommendation for future research in the clinical application of dermoscopy. First, a larger sample size of primary care providers may be helpful in the future to more thoroughly explore the objectives related to dermoscopy. Secondly, discussing the option of dermoscopy to every patient, regardless of purpose for visit, may allow providers to achieve increased hands on clinical application of dermoscopy. Supplying additional educational information including how to code for dermoscopy examinations using a CPT code (96904) may help providers correctly

document dermoscopy visits. This may potentially lead to increased reimbursement, which may increase the success of the project.

Implementing the practice of dermoscopy in clinics with access to electronic health records (EHR) may prove beneficial as well. Creation of templates for healthcare providers to chart their dermoscopy findings may ease the acceptance of the practice into the clinic setting. Utilizing the EHR to collect data on the usage of dermoscopy by healthcare providers would provide the co-investigator with additional data besides just pre- and post-implementation surveys. Data from the EHR may reveal healthcare providers' preferences for dermoscopy algorithms to focus on for future educational seminars on the practice of dermoscopy.

Application of the practice of dermoscopy into other student health clinics may also be considered a future recommendation. Benefit of instructing primary care providers on the basic use of dermoscopy over a one to two-hour course has shown to enable healthcare providers to achieve an increase in sensitivity without a decrease in specificity in triaging malignant skin lesions (Beroukhim et al., 2015). Because both primary care providers and providers at student health clinics manage many patients with similar chief complaints, the benefit of expanding the practice of dermoscopy to additional student health clinics should show similar results as in primary care clinics.

With the application to other student health clinics and primary care clinics, it would be beneficial to measure the difference among interventions performed prior to and after the implementation of dermoscopy. Comparing the interventions, including referral, excision, or reassurance and monitoring, would provide information on if the practice of dermoscopy influenced the way healthcare providers manage skin lesions in primary care.

Throughout this process, the Diffusion of Innovation Theory (DOI) was a factor that positively impacted the success of this project. The DOI provided steps to help disseminate health behavior changes into clinical practice settings, such as the practice of dermoscopy into a primary care setting. Guidance from the DOI theory was used to identify a knowledge gap; low incidence of skin cancer screenings, and fill the gap by adopting a new idea into clinical practice; which was the practice of dermoscopy.

Further guidance from the DOI theory included: 1) identifying positive adopter groups for optimum integration of the practice of dermoscopy within the clinic, 2) easily recognizing the trialability and observability of the practice of dermoscopy among both healthcare providers and patients, and 3) choosing an innovation that is compatible with goals of Student Health Services. Continued research on the practice of dermoscopy in primary care settings should include the use of the Diffusion of Innovation Theory as the model assists in the adoption of a new idea into clinical practice settings by evaluating the innovation, communication, time, and social system involved in the change (Pender et al., 2011).

Personal Growth and Development

Completing a practice improvement project focused on the topic of dermoscopy and skin cancer screening encouraged the co-investigator's professional and personal growth and development. Choosing a topic related heavily to the practice of the family nurse practitioner was one of the main goals. Additionally, the co-investigator has had personal experience with skin cancer, which served as an inspiration for the development and implementation of this project. Objectives of the project were determined by capturing a nurse practitioner's main goals when providing comprehensive patient care. These goals include disease prevention, health

maintenance, and health promotion, and are used as underpinnings throughout the development, implementation, and evaluation of this project.

One of the most influential stages of this project for the personal growth of the co-investigator included creating an educational resource and presenting the knowledge on the practice of dermoscopy to seven healthcare providers. Completing this step was both intimidating and rewarding. Presenting new and complex information to a group of professionals is a personal achievement that can be applied to future goals of the co-investigator. Seeking out opportunities to advance and share knowledge, expand horizons of the nurse practitioner role, and act as an advocate for both the nursing profession and future patients, were personal objectives the co-investigator gained from the completion of this practice improvement project.

REFERENCES

- American Academy of Dermatology. (2015). Clinical guidelines. Retrieved from <https://www.aad.org/practice-tools/quality-care/clinical-guidelines>
- American Cancer Society (ACS). (2015-2017). American cancer society guideline for the early detection of cancer. Retrieved from <http://www.cancer.org/healthy/findcancerearly/cancerscreeningguidelines/american-cancer-society-guidelines-for-the-early-detection-of-cancer>
- Baumgardner, D. J., & Rogers, A. (2014). Primary care for melanoma: Should we be screaming for screening? *Journal of Patient-Centered Research and Reviews*, 1(1), 33-40. doi:10.17294/2330-0698.1009
- Beroukhim, K., Nguyen, C., Danesh, M. J., Wu, J. J., & Koo, J. (2015). The evolving role of primary care practitioners in dermatology. *Dermatology Nurses' Association*, 7(6), 325-329.
- Boniol, M., Autier, P., Boyle, P., & Gandini, S. (2012). Cutaneous melanoma attributable to sunbed use: Systematic review and meta-analysis. *British Medical Journal*, 345(e4757), 1-12. doi:10.1136/bmj.e4757
- Bruce, A. J., & Brodlund, D. G. (2000). Overview of skin cancer detection and prevention for the primary care physician. *Mayo Clinic Proceedings*, 75, 491-500.
- Buckley, D., & McMonagle, C. (2014). Melanoma in primary care: The role of the general practitioner. *Irish Journal of Medical Science*, 183(3), 363-368. doi:10.1007/s11845-013-1021-z

- Cassarino, D. S., DeRienzo, D. P., & Barr, R. J. (2006). Cutaneous squamous cell carcinoma: A comprehensive clinicopathologic classification. *Journal of Cutaneous Pathology*, 33(4), 261-279.
- Centers for Disease Control and Prevention. (2015). Rates of new melanomas-deadly skin cancers- have doubled over last three decades. Retrieved from <http://www.cdc.gov/media/releases/2015/p0602-melanoma-cancer.html>
- Chen, L. L., Dusza, S. W., Jaimes, N., & Marghoob, A. A. (2015). Performance of the first step of the 2-step dermoscopy algorithm. *Journal of the American Medical Association Dermatology*, 151(7), 715-721. doi:10.1001/jamadermatol.2014.4642
- Chevolet, I., Hoorens, I., Janssens, A., Speeckaert, R., Van Geel, N., Van Maele, G. . . . Brochez, L. (2015). A short dermoscopy training increases diagnostic performance in both inexperienced and experienced dermatologists. *Australasian Journal of Dermatology*, 56, 52-55. doi:10.1111/adj.12203
- Cunningham, C. T., Quan, H., Hemmelgarn, B., Noseworthy, T., Beck, C. A., Dixon, E. . . . Jette, N. (2015). Exploring physician specialist response rates to web-based surveys. *BioMed Central Medical Research Methodology*, 15(32), 1-8. doi:10.1186/s12874-015-0016-z
- Curiel-Lewandrowski, C. (2016). Risk factors for the development of melanoma. Retrieved from http://www.uptodate.com/contents/risk-factors-for-the-development-of-melanoma?source=search_result&search=melanoma+risk+factors&selectedTitle=1~150
- Curiel-Lewandrowski, C., Chen, S. C. & Swetter, S. M. (2012). Screening and prevention measures for melanoma: Is there a survival advantage? *Current Oncology Reports*, 14(5), 458-467. doi:10.1007/s11912-012-0256-6

- DermLite. (2017). DermLite DL100. Retrieved from <https://dermlite.com/collections/frontpage/products/dermlite-dl100>
- Garberg, T. (2008). *Understanding students' indoor tanning practices and beliefs* (Doctoral dissertation). North Dakota State University, North Dakota.
- Geller, A. C. & Swetter, S. (2016). Screening and early detection of melanoma. Retrieved from <https://www.uptodate.com/contents/screening-and-early-detection-of-melanoma?source=preview&search=skin+cancer+screening&language=en-US&anchor=H1159434&selectedTitle=1~18#H2348977199>
- Harvard Health Publications. (2013). Basal cell carcinoma. Retrieved from https://ezproxy.lib.ndsu.nodak.edu/login?url=http://search.credoreference.com/content/entry/hhphealth/basal_cell_carcinoma/0
- Herschorn, A. (2012). Dermoscopy for melanoma detection in family practice. *Canadian Family Physician*, 58(7), 740-745.
- Howlander, N., Noone, A. M., Krapcho, M., Garshell, J., Miller, D., Altekruse, S. F., . . . Cronin, K. A. (2015). SEER Cancer Statistics Review, 1975-2012, National Cancer Institute. Retrieved from http://seer.cancer.gov/archive/csr/1975_2012/#contents
- Jaimes, N., & Marghoob, A. A. (2015). Dermoscopic algorithms for skin cancer triage. Retrieved from http://www.uptodate.com/contents/dermoscopic-algorithms-for-skin-cancer-triage?source=see_link
- Jaimes, N., Marghoob, A. A., Rabinovits, H., Braun, R. P., Cameron, A., Rosendahl, C., . . . Keir, J. (2015). Clinical and dermoscopic characteristics of melanomas on nonfacial chronically sun-damaged skin. *American Academy of Dermatology*, 72(6), 1027-1036. doi:10.1016/j.jaad.2015.02.1117

- Jones, J. R. (2013). Theory into practice. *Nursing Standard*, 27(19), 61.
- Karia, P. S., Han, J., & Schmults, C. D. (2013). Cutaneous squamous cell carcinoma: Estimated incidence of disease, nodal metastasis, and deaths from disease in the United States, 2012. *Journal of the American Academy of Dermatology*, 68(6), 957-966.
doi:10.1016/jaad.2012.11.037
- Koelink, C. J. L., Vermeulen, K. M., Kollen, B. J., de Bock, G. H., Dekker, J. H., Jonkman, M. F., & van der Heide, W. K. (2013). Diagnostic accuracy and cost-effectiveness of dermoscopy in primary care: A cluster randomized clinical trial. *Journal of the European Academy of Dermatology and Venereology*, 28(11), 1442-1449. doi:10.1111/jdv.12306
- Kownacki, S. (2014). Skin diseases in primary care: What should GPs be doing? *British Journal of General Practice*, 64(625), 380-381. doi:10.3399/bjgp14X680773
- Lallas, A., Apalla, Z., & Chaidemenos, G. (2012). New trends in dermoscopy to minimize the risk of missing melanoma. *Journal of Skin Cancer*, 2012, 1-5. doi:10.1155/2012/820474
- Liebman, T. N., Goulart, J. M., Soriano, R., Dusza, S. W., Halpern, A. C., Lee, K. K., & Marghoob, A. A. (2012). Effect of dermoscopy education on the ability of medical students to detect skin cancer. *Archives of Dermatology Journal*, 148(9), 1016-1022.
doi:10.1001/archdermatol.2012.509
- Little, E. G., & Eide, M. J. (2012). Update on the current state of melanoma incidence. *Dermatology Clinic*, 30, 355-361. doi:10.1016/j.det.2012.04.001
- Lim, J. L. & Asgari, M. (2016). Clinical features and diagnosis of cutaneous squamous cell carcinoma (SCC). Retrieved from https://www.uptodate.com/contents/clinical-features-and-diagnosis-of-cutaneous-squamous-cell-carcinoma-scc?source=search_result&search=squamous+cell+carcinoma+skin&selectedTitle=2~15

- Lowell, B. A., Froelich, C. W., Federman, D. G., & Kirsner, R. S. (2001). Dermatology in primary care: Prevalence and patient disposition. *Journal of the American Academy of Dermatology*, 45(2), 250-255.
- Marghoob, A. A., & Jaimes, N. (2015). Overview of dermoscopy. Retrieved from http://www.uptodate.com/contents/overview-of-dermoscopy?source=search_result&search=dermoscopy&selectedTitle=1~55
- McCourt, C., Dolan, O., & Gormley, G. (2014). Malignant melanoma: A pictorial review. *The Ulster Medical Society*, 83(2), 103-110.
- Melnyk, B. M. & Fineout-Overholt, E. (2011). *Evidence-based practice in nursing & healthcare: A guide to best practice*. Philadelphia: Wolters Kluwer Health/Lippincott Williams & Wilkins.
- Menzies, S. W., Ingvar, C., Crotty, K. A., & McCarthy, W. H. (1996). Frequency and morphologic characteristics of invasive melanomas lacking specific surface microscopic features. *Archives of Dermatology*, 132(10), 1178-1182.
doi:10.1001/archderm.1996.03890340038007
- Murzaku, E. C., Hayan, S., & Rao, B. K. (2014). Methods and rates of dermoscopy usage: A cross-sectional survey of US dermatologists stratified by years in practice. *Journal of the American Academy of Dermatology*, 71(2), 393-395.
- Nachbar, F., Stoltz, W., Merkle, T., Cognetta, A. B., Vogt, T., Landthaler, M., . . . Plewig, G. (1994). The ABCD rule of dermoscopy. High prospective value in the diagnosis of doubtful melanocytic skin lesions. *Journal of American Academy of Dermatology*, 30(4), 551-9.

National Ambulatory Medical Care Survey. (2013). 2013 State and national summary tables.

Retrieved from

https://www.cdc.gov/nchs/data/ahcd/namcs_summary/2013_namcs_web_tables.pdf

North Dakota State University [NDSU]. (2016). Nursing. Retrieved from

<https://www.ndsu.edu/majors/nursing/>

Oakley, A. (1997, updated 2015). Dermoscopy. Retrieved from

<http://www.dermnetnz.org/procedures/dermoscopy.html>

Oliveria, S. A., Heneghan, M. K., Cushman, L. F., Ughetta, E. A., & Halpem, A. C. (2011). Skin cancer screening by dermatologists, family practitioners, and internists: Barriers and facilitating factors. *Archives of Dermatology*, *147*(1), 39-44.

doi:10.1001/archdermatol.2010.414

Pluddemann, A., Heneghan, C., Thompson, M., Wolstenholme, J., & Price, C. P. (2011).

Dermoscopy for the diagnosis of melanoma: Primary care diagnostic technology update.

British Journal of General Practice, *61*, 416-417. doi:10.3399/bjgp11X578142

Primary Care Dermatology Society. (2016). Actinic keratosis (syn. Solar keratosis). Retrieved

from <http://www.pcids.org.uk/clinical-guidance/actinic-keratosis-syn.-solar-keratosis>

Siegel, R., Ma, J., Zou, Z., & Jemal, A. (2014). Cancer statistics. *A Cancer Journal for*

Clinicians, *64*(1), 9.

Soyer, H. P., Giuseppe, A., Zalaudek, I., Corona, R., Sera, F., Talamini, R., . . . Chimenti, S.

(2004). Three-point checklist of dermoscopy. A new screening method for early detection of melanoma. *Dermatology*, *208*(1), 27-31. doi:10.1159/000075042

Steelman, V. M. (2016). The Iowa model: Letter to the editor. *Association of Perioperative*

Registered Nurses, *103*(1), 5. doi:10.1016/j.aorn.2015.11.020

- Swetter, S. M. & Geller, A. C. (2015). Clinical feature and diagnosis of cutaneous melanoma. Retrieved from <http://www.uptodate.com/contents/clinical-features-and-diagnosis-of-cutaneous-melanoma?source=preview&search=glasgow+seven+point&language=en-US&anchor=H10374288&selectedTitle=1~150#H10374288>
- Swetter, S. M., Pollitt, R. A., Johnson, T. M., Brooks D. R., & Geller, A. C. (2012). Behavioral determinants of successful early melanoma detection. *Cancer Journal*, 118(15) doi:10.1002/cncr.26707
- United States Preventative Services Task Force (USPSTF). (2015). What screening tests are there? Retrieved from http://www.cdc.gov/cancer/skin/basic_info/screening.htm
- Veness, M. J. (2007). High-risk cutaneous squamous cell carcinoma of the head and neck. *Journal of Biomedicine and Biotechnology*, 2007, 1-6. doi:10.1155/2007/80572
- Walter, F. M., Prevost, A. T., Vasconcelos, J., Hall, P. N., Burrows, N. P., Morris, H. C., . . . Emery, J. D. (2013). Using the 7-point checklist as a diagnostic aid for pigmented skin lesions in general practice. *British Journal of General Practice*, 63(610), 345-353. doi:10.3399/bjgp13X667213
- Wehner, M. R., Chren, M. M., Nameth, D., Choudhry, A., Gaskins M., Nead, K. T. . . . Linos, E. International prevalence of indoor tanning: A systemic review and meta-analysis. *Journal of the American Medical Association of Dermatology*, 150(4), 390-400. doi:10.1001/jamadermatol.2013.6896
- Weir, H. K., Marrett, L. D., Cokkinides, V., Barnholtz-Sloan, Patel, P., Tai, E., . . . Ekwueme, D. U. (2011). Melanoma in adolescents and young adults (ages 15-39 years): United States, 199-2006. *Journal of the American Academy of Dermatology*, 65(5), 38-49. doi:10.1016/j.jaad.2011.04.038

Zalaudek, I., Nowotny, T., Kittler, H., Hofmann-Wellenhof, R., & Massone, C. (2015). The brown and black rule: A simple clue to differentiate common naevi from spitzoid neoplasms with dermoscopic uniform globular (clod) pattern. *Journal of the European Academy of Dermatology and Venereology*, 1-2. doi:10.1111/jdv.13041

APPENDIX A. PERMISSION TO USE AND/OR REPRODUCE THE IOWA MODEL

(1998)

Permission to Use and/or Reproduce the Iowa Model (1998)

Kimberly Jordan – University of Iowa Hospitals and Clinics <noreply@qemail>

To: Erin Hencley

March 6th, 2016

You have permission, as requested today, to review/use the 1998 *Iowa Model of Evidence-Based Practice to Promote Quality Care* (Titler et al., 2001).

Copyright of *The Iowa Model of Evidence-Based Practice to Promote Quality Care* will be retained by The University of Iowa Hospitals and Clinics. Click the link below to open the model.

Permission is not granted for placing the Iowa Model on the internet.

The Iowa Model- 1998

In written material, please add the following statement:

- *Used/Reprinted with permission from the University of Iowa Hospitals and Clinics. Copyright 1998. For permission to use or reproduce the model, please contact the University of Iowa Hospitals and Clinics at (319)384-9098.*

If you have questions, please contact Kimberly Jordan at 319-384-9098 or kimberly-jordan@uiowa.edu.

APPENDIX B. THE IOWA MODEL OF EBP

The Iowa Model of Evidence-Based Practice to Promote Quality Care

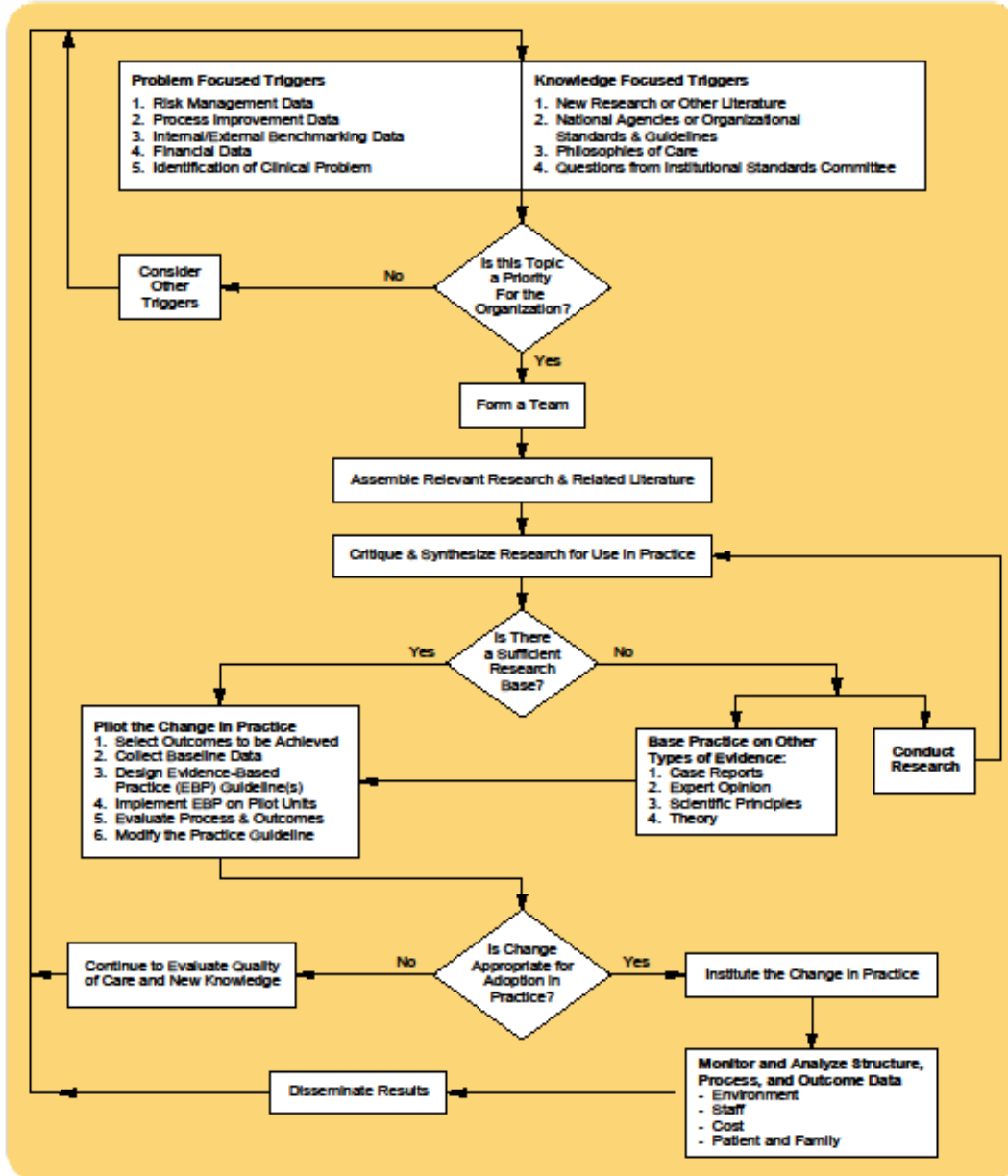

◇ = a decision point

Titler, M.G., Kleiber, C., Steelman, V.J., Rakel, B. A., Budreau, G., Everett, L.O., Buckwalter, K.C., Tripp-Reimer, T., & Goode C. (2001). The Iowa Model Of Evidence-Based Practice to Promote Quality Care. *Critical Care Nursing Clinics of North America*, 13(4), 497-509.

REQUESTS TO:
Department of Nursing
University of Iowa Hospitals and Clinics
Iowa City, IA 52242-1009

DO NOT REPRODUCE WITHOUT PERMISSION

Revised April 1998 © UIHC

Used/Reprinted with permission from the University of Iowa Hospitals and Clinics. Copyright 1998.

**APPENDIX C. APPROVAL FROM THE NDSU STUDENT HEALTH CENTER FOR
PROJECT IMPLEMENTATION**

Skin Cancer Dissertation Inquiry

Sheryll Clapp

To: Erin Hencley

May 13th, 2015, 4:55pm

Hi Erin,

We discussed your proposal at our meeting and would be willing to participate in your project. We had a discussion on the use of the dermascope and some of us would use that and others actually prefer a magnifying glass and good light (Jean Seltvedt's nephew is a dermatologist and he prefers the latter – so that is what Jean prefers). Our nine month staff come back the week of August 17th – so would need to discuss implementation after that time. You can contact me over this summer if you have any questions, etc as I am in during the summer, but in a little less. I would be happy to sit on your committee – you can let me details as they develop. Hope you have a good summer.

Sheryll

APPENDIX D. PERMISSION TO USE DERMNET NZ IMAGES

Permission to Copy from DermNet

Amanda Oakley Amanda.oakley@me.com

To: Erin Hencley

April 28th, 2016 2:35pm

Thank you for your inquiry and interest in DermNet images.

You are very welcome to use DermNet NZ's watermarked pictures for personal reasons, or for your teaching session or non-commercial project, providing their source is acknowledged (DermNetNZ.org), and that you don't alter or sell them.

We can supply digital images suitable for publication in a standard text, journal or brochure for a fee. For details, refer to <http://www.dermnetnz.org/disclaimer.html#copy>.

Amanda Oakley MBChB FRACP PGDipHealInf FNZDS

Website Manager, DermNet New Zealand Trust

c/o Tristram Clinic Ltd, 200 Collingwood Street, Hamilton 3204, New Zealand

email: amanda.oakley@me.com, website: <http://www.dermnetnz.org>

APPENDIX E. PRE-IMPLEMENTATION SURVEY

Healthcare providers: Please fill out the following survey to assist the co-investigator in identifying current strengths and needs with your experience with dermoscopy. Participation is completely voluntary, yet greatly appreciated.

1-Strongly Disagree 2-Disagree 3-Agree 4-Strongly Agree

I am knowledgeable about skin cancer prevalence and prevention strategies	-1- Strongly disagree	-2- Disagree	-3- Agree	-4- Strongly agree
I feel comfortable performing naked eye skin examinations	-1- Strongly disagree	-2- Disagree	-3- Agree	-4- Strongly agree
I feel comfortable with the practice of dermoscopy	-1- Strongly disagree	-2- Disagree	-3- Agree	-4- Strongly agree
I feel that using dermoscopy will benefit my practice and my patients	-1- Strongly disagree	-2- Disagree	-3- Agree	-4- Strongly agree

What do you consider your current level of knowledge of dermoscopy?	-1- Novice	-2- Advanced beginner	-3- Competent	-4- Proficient	-5- Expert
---	---------------	--------------------------	------------------	-------------------	---------------

APPENDIX F. POST-IMPLEMENTATION SURVEY

Healthcare providers: Please fill out the following survey to assist the co-investigator in identifying current strengths and needs with your experience with dermoscopy. Participation is completely voluntary, yet greatly appreciated.

1-Strongly Disagree 2-Disagree 3-Agree 4-Strongly Agree

I am knowledgeable about skin cancer prevalence and prevention strategies	-1- Strongly disagree	-2- Disagree	-3- Agree	-4- Strongly agree
I feel comfortable performing naked eye skin examinations	-1- Strongly disagree	-2- Disagree	-3- Agree	-4- Strongly agree
I feel comfortable with the practice of dermoscopy	-1- Strongly disagree	-2- Disagree	-3- Agree	-4- Strongly agree
I feel that using dermoscopy will benefit my practice and my patients	-1- Strongly disagree	-2- Disagree	-3- Agree	-4- Strongly agree

What do you consider your current level of knowledge of dermoscopy?	-1- Novice	-2- Advanced beginner	-3- Competent	-4- Proficient	-5- Expert
---	---------------	--------------------------	------------------	-------------------	---------------

APPENDIX G. WELCH ALLYN EPISCOPE SKIN SURFACE MICROSCOPE

BROCHURE (A)



Welch Allyn™ | A powerful skin surface microscope

Pigmented skin lesions are often difficult to diagnose by their clinical appearance alone, yet they have potentially dangerous consequences. The Welch Allyn EpiScope is an advanced skin surface microscope featuring a 10X magnification optics system that provides greater detail to help with the early detection of suspicious skin lesions and moles so you can feel confident in an accurate diagnosis.

WelchAllyn
Advancing Frontier Care™

APPENDIX H. WELCH ALLYN EPISCOPE SKIN SURFACE MICROSCOPE
BROCHURE (B)

More accurate diagnoses

Bright 3.5 v halogen illumination and advanced 10X optics system ensure accurate identification of suspicious lesions.

Reduced risk of cross-contamination
Removable contact plate is autoclavable to help reduce any possibility of cross-contamination.

Comfortable eyepiece
Soft rubber eyewear protector allows you to comfortably place the EpiScope between your eye and the patient's lesion.

Easy to focus
Large, knurled focusing ring provides sharp focus on moles or lesions.

Attaches to rechargeable handles
Fits on any Welch Allyn 3.5v battery power source for convenience and cost savings.

Reticle contact plate
Easily provides measurements in (mm) of a suspicious lesion.

Fully portable
Soft carrying case accommodates handle and includes pouch for extra front cover.

Ordering Information

- 47200 3.5 v Halogen EpiScope (instrument head only) with Reticle Contact Plate
- 60800 3.5 v Halogen replacement lamp for No. 47200 EpiScope.
- 47201 3.5 v Halogen EpiScope Set, includes EpiScope with Reticle Contact Plate, 71000 3.5 v Rechargeable Handle with rich alkaline battery and 85230 Soft Carrying Case
- 47205 Same as 47201 but export (Specify country and voltage). Conforms to IEC 609-1, 720-720 V, 50/60 Hz.
- 47310 Reticle Contact Plate
- 47320 Plano Contact Plate
- 85230 Soft Carrying Case

WelchAllyn
Advancing Patient Care™

Welch Allyn Corporate Headquarters
4011 Stone Street Road, 100, Box 200, Watertown, MA, 01093-0001 USA
(p) 800.325.6863 (t) 215.685.3361
www.welchallyn.com

©2017 Welch Allyn 330788 Rev B

APPENDIX I. WELCH ALLYN EPISCOPE SKIN SURFACE MICROSCOPE USER INFORMATION

WelchAlllyn

Welch Alllyn EpiScope™ Skin Surface Microscope
Directions for Use

47300

Mat. No 719632 Ver. B
© 2013 Welch Alllyn, Inc.



Intended use

Allows visualization and measurement of skin surface lesions.

Symbols

WARNING identifies information within the manual to avoid injury.

CAUTION identifies information within the manual to avoid equipment failure.

Temperature Range

Humidity Range

Meets essential requirements of European Medical Device Directive 93/42/EEC.

Do not dispose of this product as unsorted municipal waste. Prepare this product for reuse or separate collection as specified by Directive 2002/96/EC of the European Parliament and the Council of the European Union on Waste Electronic and Electrical Equipment (WEEE). If this product is contaminated, this directive does not apply.

For more specific disposal information, see www.welchallyn.com/weee, or contact Welch Alllyn Customer Service +44 207 365 6780.

Warnings and cautions

WARNING This cleaning and disinfection procedure and the equipment and materials described must be followed and conducted by persons trained and familiar with medical device cleaning and disinfection.

WARNING Consult your facility's procedures and the reprocessing agents manufacturer's instructions for the agents reuse, recommended Personal Protective Equipment, and other safety precautions.

WARNING Lamps may be hot. Allow to cool before removal. Handle and dispose of the lamp with care to avoid shattering. Use protective eyeglasses when handling.

WARNING The EpiScope is intended to be used ONLY with intact skin.

CAUTION Failure to follow these instructions may cause damage to this device.

CAUTION Do not immerse or allow excessive moisture to contact the EpiScope. Doing so may cause damage to the device.

CAUTION Only use the cleaner/disinfectant types identified within these instructions. Do not use other cleaners or disinfectants.

CAUTION Always follow the cleaner or disinfectant manufacturers' instructions for proper use.

CAUTION Repeated reprocessing may degrade elements of the device. Follow inspection procedures to assure damage has not occurred.

CAUTION Do not use abrasive material to clean lens. Doing so can scratch and permanently damage optics.

CAUTION The EpiScope is not for diagnostic purpose/use.

Components

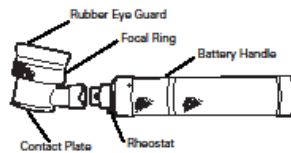

Instructions

1. Install EpiScope onto Welch Alllyn 3.5v handle.

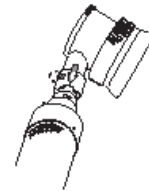

2. Power ON

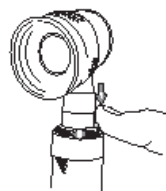

3. Center EpiScope over lesion to examine surface and adjust focal ring



Note: To reduce glare, moisten skin with oil.



Note: Roll back rubber eye guard if you wear glasses.

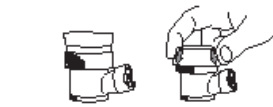

Note: To examine raised moles or lesions, remove contact plate.

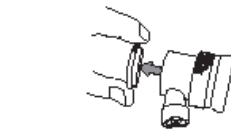

APPENDIX J. DERMLITE DL100 POCKET EPILUMINESCENCE MICROSCOPY

DEVICE BROCHURE (A)

dermlite®
DL100

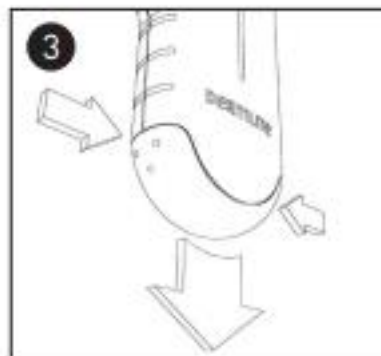
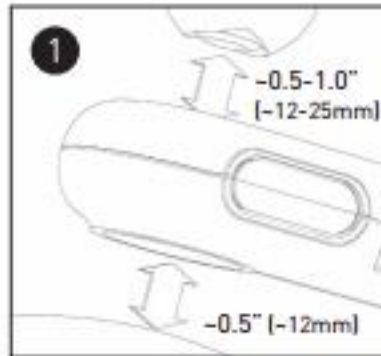

APPENDIX K. DERMLITE DL100 POCKET EPILUMINESCENCE MICROSCOPY

DEVICE BROCHURE (B)

English

Instructions

CAUTION: Prior to using the DermLite read these instructions and keep them in a safe place for future reference.

CAUTION: United States Federal Law restricts this device to sale by or on the order of a physician.

CAUTION: The DermLite is designed for external examination only.

The DermLite is a pocket epiluminescence microscopy (PELM) device designed to view skin lesions with high magnification and clarity.

White LED lighting technology combined with a 10x Hastings Triplet lens provides for ideal skin microscopy. The LED daylight-type light is linearly polarized, and a second polarizing lens is aligned to cancel the reflected light from the skin. A high quality, three-element lens with 10x magnification, superb color correction, and reduced image distortion is used to image the skin.

Directions for Use (Fig. 1-2)

CAUTION: Do not look directly into the bright LED Light. Patients must close their eyes during facial examinations.

Hold the DermLite so that the LEDs are aimed in the direction of the lesion to be examined. Place the DermLite approximately 1/2" (~12mm) from the skin (Fig. 1). If necessary, use your fingers to maintain optimum spacing. Press the power switch (Fig. 2) at the side of the unit to activate the LEDs. If you are right-handed, use your thumb to activate the button and hold it down as long as you need light. If you are left-handed, use your forefinger to activate the power button.

Look through the lens with your eye placed 1/2" (~12mm) to 1" (~25mm) above the DermLite (Fig. 1). Move the DermLite closer or further away from the lesion to obtain the desired image focus.

Replacing the Battery (3)

The long-life 6V Lithium battery provides up to 8 hours of continuous operation, or enough power for imaging approximately 1200 lesions at 30 seconds per examination.

To change the battery (Fig. 3), squeeze the cap by its sides and remove it and the battery. Insert a new battery of the same type with the contacts facing forward. Replace the battery cap securely on the device.

The DermLite uses a 2CR5 Lithium Battery, which may be purchased from camera stores and other retailers. You may also purchase batteries from 3Gen at low prices.

Troubleshooting

Please check our website (www.DermLite.com) for the most current troubleshooting information.

If you need to return the DermLite to 3Gen for servicing, please call 3Gen prior to returning the device, and a unique Return Merchandise Number (RMA) will be issued to you.

No Light

Replace the battery with a new, unused battery and check again. If the condition persists, send the unit to 3Gen for evaluation and/or repair.

Weak Lighting

Replace the battery with a new battery (you have approximately 30 minutes of battery life before the unit will not function.)

Light Flickers

Remove the battery and check its metal contacts for dirt or dust. Wipe off any dust and reinsert the battery. If there are signs of corrosion, discard the battery and replace it with a new battery. Should you still encounter flickering, return the DermLite to 3Gen for evaluation and/or repair.

LED Fails

The LEDs used in the DermLite are designed to last over 100,000 hours. If any of the eight LEDs fail, return the DermLite to 3Gen for repair.

Care and Maintenance

The DermLite is designed for trouble-free operation. There are no adjustments to be made nor is any special servicing required. Never attempt to open the device for any reason.

Cleaning and Sterilization

The DermLite body may be cleaned or disinfected by wiping it with Isopropyl alcohol (70% vol.). Do not use alcohol or disinfectants in the optical areas of the unit. Do not use abrasive material on any part of the equipment or immerse the device in liquid. Do not autoclave.

Cleaning the Lens and the Polarizers

The lens and the polarizing filters should be treated as high quality photographic equipment and should be cleaned with standard lens cleaning equipment and protected from harmful chemicals.

Specifications

The DermLite features an optical microscope system designed for superb clarity and glare-free vision. DermLite components include:

- Eight 3mm White LEDs
- 10x Hastings Triplet Lens
- Linear Cross-Polarization Lenses
- 1300mAh/6 Volts, 2CR5 Lithium Battery

Warranty

5 years for parts and labor.

APPENDIX L. SKIN CANCER HANDOUT

Skin Cancer

ONE in **FIVE** Americans will develop some form of skin cancer during their lifetime

Skin Cancer:
The most common type of cancer

Non-melanoma Skin Cancer: Usually slow growing, rarely spreading, highly curable

- ✓ Basal Cell Cancer
- ✓ Squamous Cell Cancer

Melanoma Skin Cancer: Makes up 1% of all skin cancers, but most deadly

- ✓ Malignant Melanoma

Risk Factors

- ✓ Tanning bed use
- ✓ Large number of moles
- ✓ Family or personal history of skin cancer
- ✓ Lighter natural skin color
- ✓ Green or blue eyes
- ✓ Blonde or red hair
- ✓ Sunburns

Tanning Bed Use

Sunburns

- ✓ Skin cancer risk **DOUBLES** with 5 or more sunburns in a lifetime
- ✓ Tanning bed users are **2.5x more likely to develop squamous cell cancer** and **1.5x more likely to develop basal cell cancer**
- ✓ Even using a tanning bed **ONE TIME** before age 35 increases the risk of melanoma by 75%
- ✓ There is **no such thing as a "safe" tan or "base" tan**, this does not prevent further skin damage from sun exposure

How Can I Reduce My Skin Cancer Risk?

- ✓ **Do Not Burn.** Too much sun exposure is the most preventable risk factor for skin cancer.
- ✓ **Avoid Tanning Beds.** UV light from tanning beds causes skin cancer and premature wrinkles.
- ✓ **Use Sunscreen Year Round.** Apply broad spectrum sunscreen with SPF 30 or higher. Reapply every 2 hours and after swimming or sweating.
- ✓ **Cover Up.** Wear protective clothing; wide-brimmed hat, long sleeves, long pants, and sunglasses with 99-100% UVA/UVB protection.
- ✓ **Find Shade.** Sit in the shade when the sun's rays are the strongest between 10 a.m. and 4 p.m.
- ✓ **Check the UV Index.** Watch the UV index when planning outdoor activities to avoid overexposure.
- ✓ **Monitor Your Skin.** Observe your skin for new or changing moles. Talk to your primary care provider about any skin concerns.

Centers for Disease Control and Prevention. (2011). *Fact about: Skin cancer* [Fact Sheet]. Retrieved from <https://www.epa.gov/sites/production/files/documents/web.pdf>

The Skin Cancer Foundation. (2016). Melanoma. Retrieved from <http://www.skincancer.org/skin-cancer-information/melanoma>

APPENDIX K. EXECUTIVE SUMMARY

Background and Significance

Skin cancer is one of the most common forms of cancer. Approximately one in five Americans will develop skin cancer during a lifetime (ACS, 2017). Of all skin cancer forms, cutaneous malignant melanoma accounts for less than 1% of skin cancer cases, but the majority of skin cancer deaths (ACS, 2017). The overall incidence of melanoma has doubled since 1973. In 2017, it is estimated that there will be 87,100 new cases of cutaneous malignant melanoma and 9,730 deaths from the disease in the United States (ACS, 2017). Identification of all forms of skin cancer is primarily done through skin cancer screenings, however, skin cancer screening examinations are only performed at 8%- 21% of all annual physical examination visits (Curiel-Lewandrowski, 2016). Healthcare providers identify barriers to performing routine skin cancer examinations including a lack of training and lack of consistent screening method. Therefore, the key to increasing the rate of skin cancer screenings is to provide education and clinical practice of a consistent screening method, such as dermoscopy, to healthcare providers.

Project Summary

The purpose of the project was multidimensional. Primarily, this project aimed to improve the knowledge and comfortability of the practice of dermoscopy among healthcare providers at NDSU Student Health Services. An additional purpose was to demonstrate and promote sustainability of the practice of dermoscopy within the clinic by creating an education resource and presenting a presentation on the history, algorithm use, and clinical application and management of dermoscopy. Once the co-investigator had created and presented education on dermoscopy, healthcare providers were instructed to use their dermoscopy skills on patients visiting the clinic over the following three months. Pre- and post-surveys were administered prior

to and right after the three-month implementation period. Three in person visits were made during the implementation period by the co-investigator to evaluate the progress of the project and answer questions from healthcare providers.

Results

Analysis included the results of pre- and post-implementation surveys conducted through Qualtrics. Results show that 0% of providers felt comfortable with the practice of dermoscopy on the pre-survey compared with the post-survey, where 66.67% of providers felt comfortable with the practice. On the pre-survey, approximately 71.43% of responders considered themselves a novice in the practice of dermoscopy and 28.57% considered themselves an advanced beginner. Post-survey results show these numbers as 66.67% and 33.33%, respectively. Lastly, pre-survey results showed that 71.25% of providers considered dermoscopy useful to their practice, compared with 100% on the post-survey.

Overall, the conclusion can be made that the healthcare providers at NDSU Student Health Services became more comfortable and knowledgeable in the practice and clinical application of dermoscopy by the conclusion of the three-month implementation period. Additionally, those who did not believe on the pre-survey that the practice of dermoscopy would benefit their patients and personal practice, were found to all agree by the post-survey that the practice of dermoscopy was beneficial to their patients and clinical practice. The essential goal of this project was to improve the comfortability and knowledge, and demonstrate the usefulness of the practice and clinical application of dermoscopy among healthcare providers.

Recommendations

One major recommendation identified through the completion of this project includes the implementation of the practice of dermoscopy into additional campus health centers and primary

care clinics. This recommendation would provide healthcare professionals with the tools and education they require to comfortably perform routine skin examinations with a dermatoscope and confidently provide appropriate management for patients with dermatologic concerns. With the number of dermatologic concerns seen by primary care providers in outpatient clinics, education on the practice of dermoscopy would be highly beneficial for both healthcare providers and patients alike.